

ab 04.01.2017
from 04.01.2017
à partir du 04.01.2017

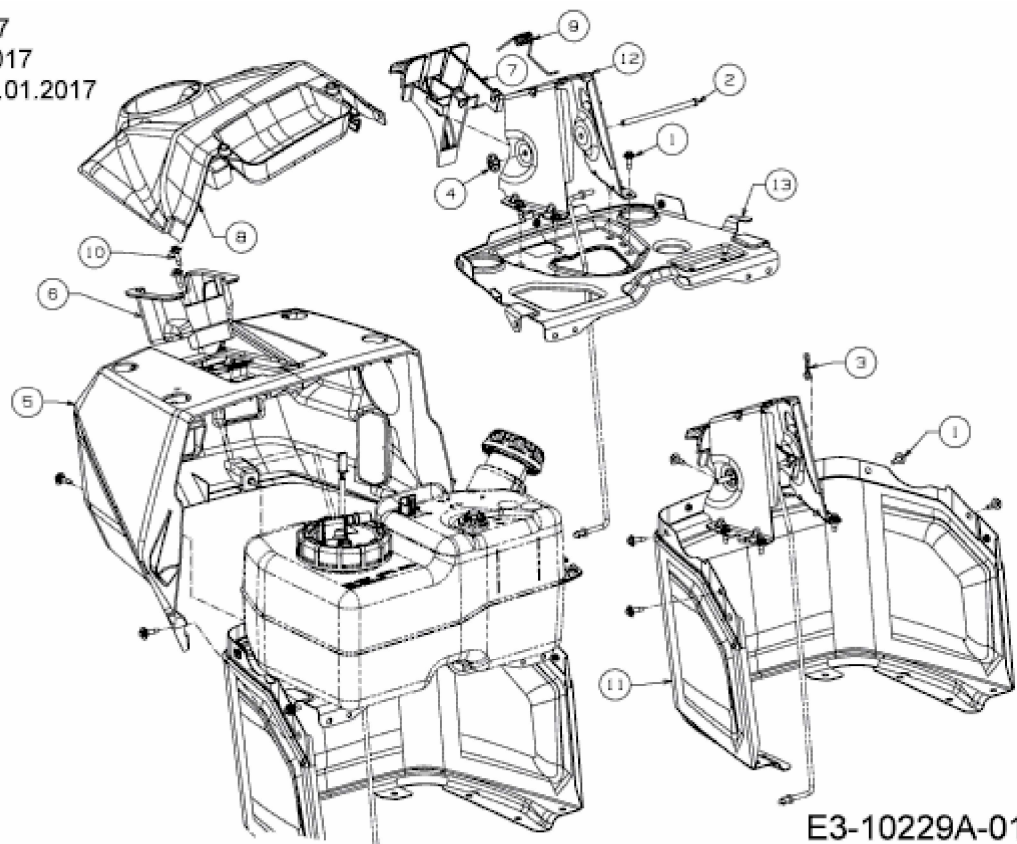

E3-10229A-01