

ab 11.11.2016
from 11.11.2016
à partir du 11.11.2016

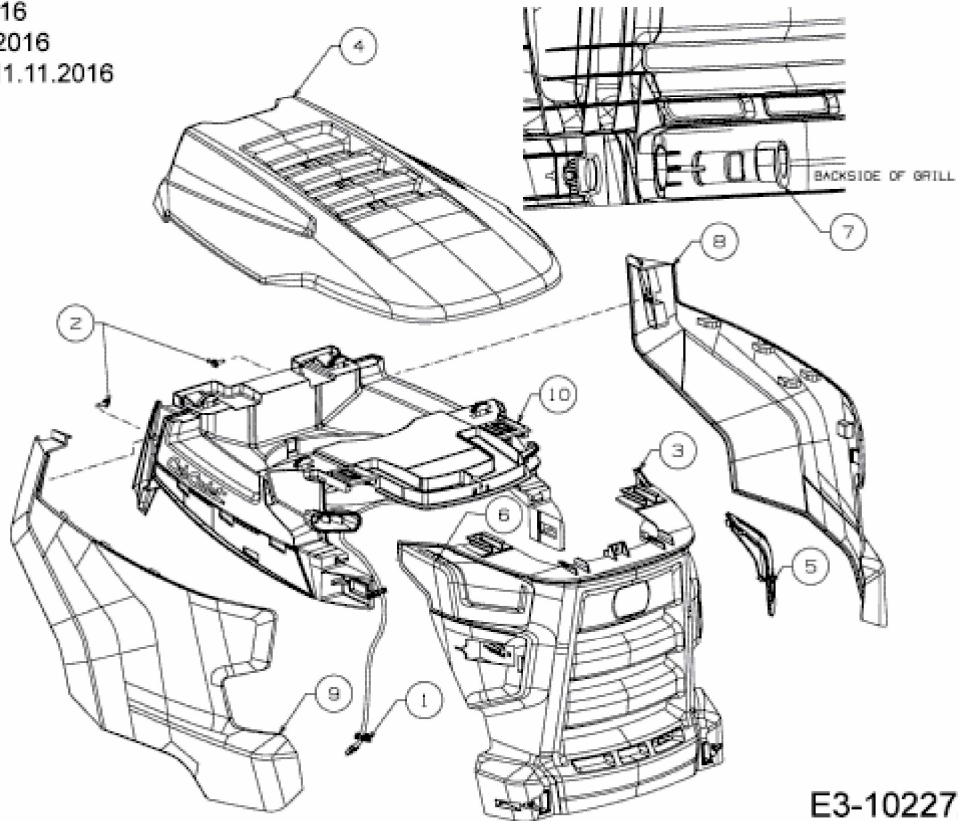

E3-10227A-01