

ab 01.03.2013
from 01.03.2013
à partir du 01.03.2013

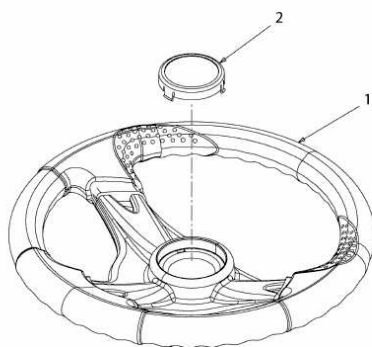

E3-02341A-02