

ab 01.01.2008  
from 01.01.2008  
à partir du 01.01.2008

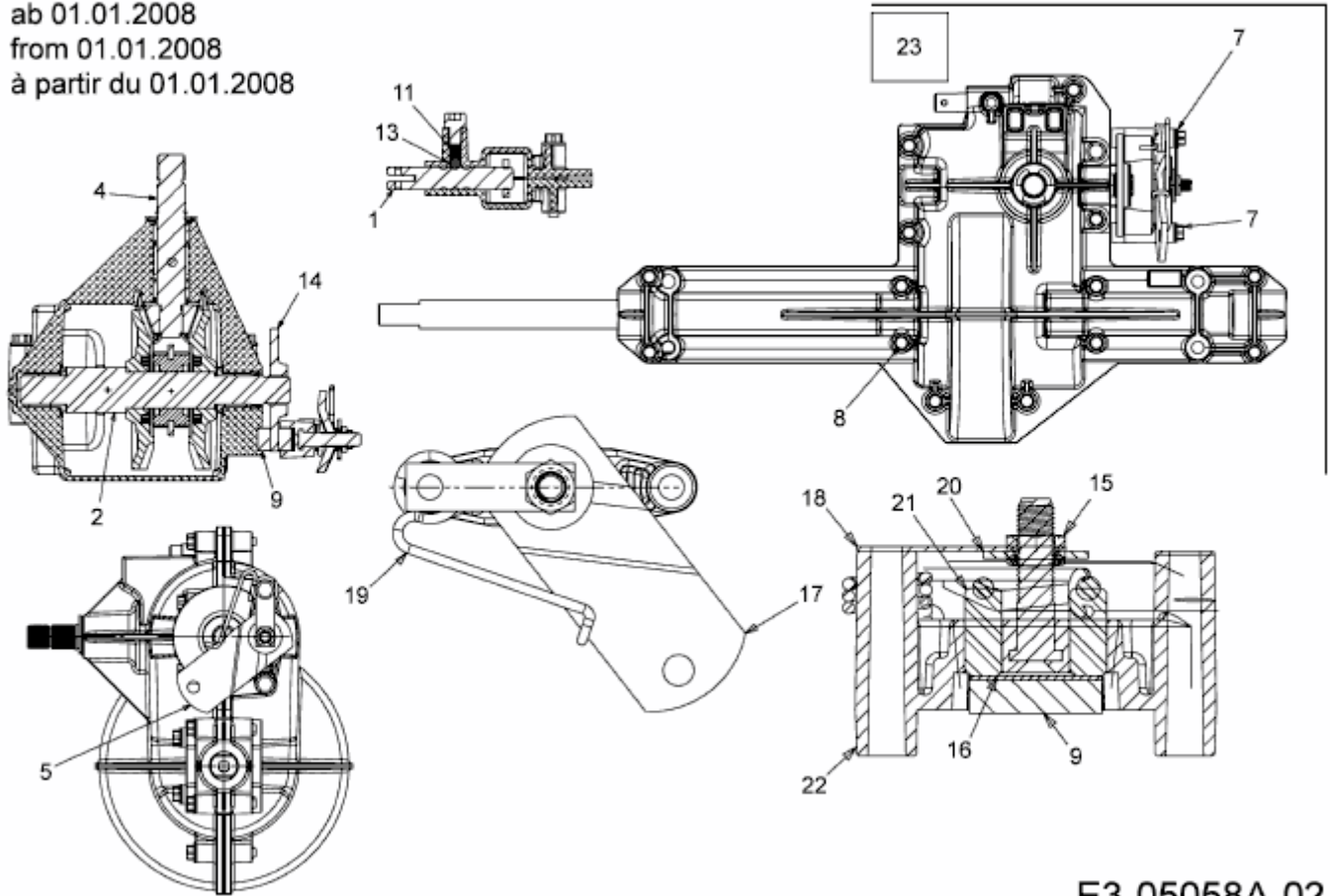

E3-05058A-02