

ab 01.01.2008
from 01.01.2008
à partir du 01.01.2008

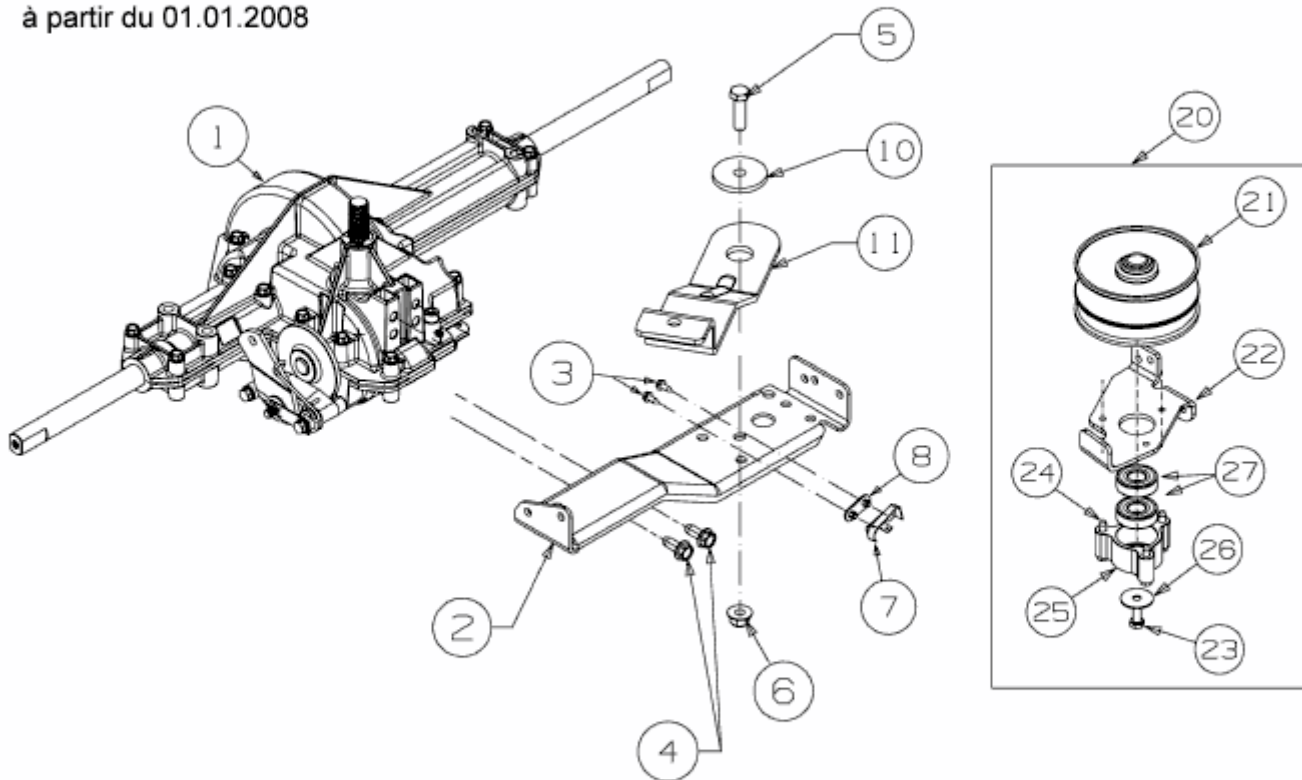

E3-04317A-01