

bis 31.12.2007
to 31.12.2007
jusqu'au 31.12.2007

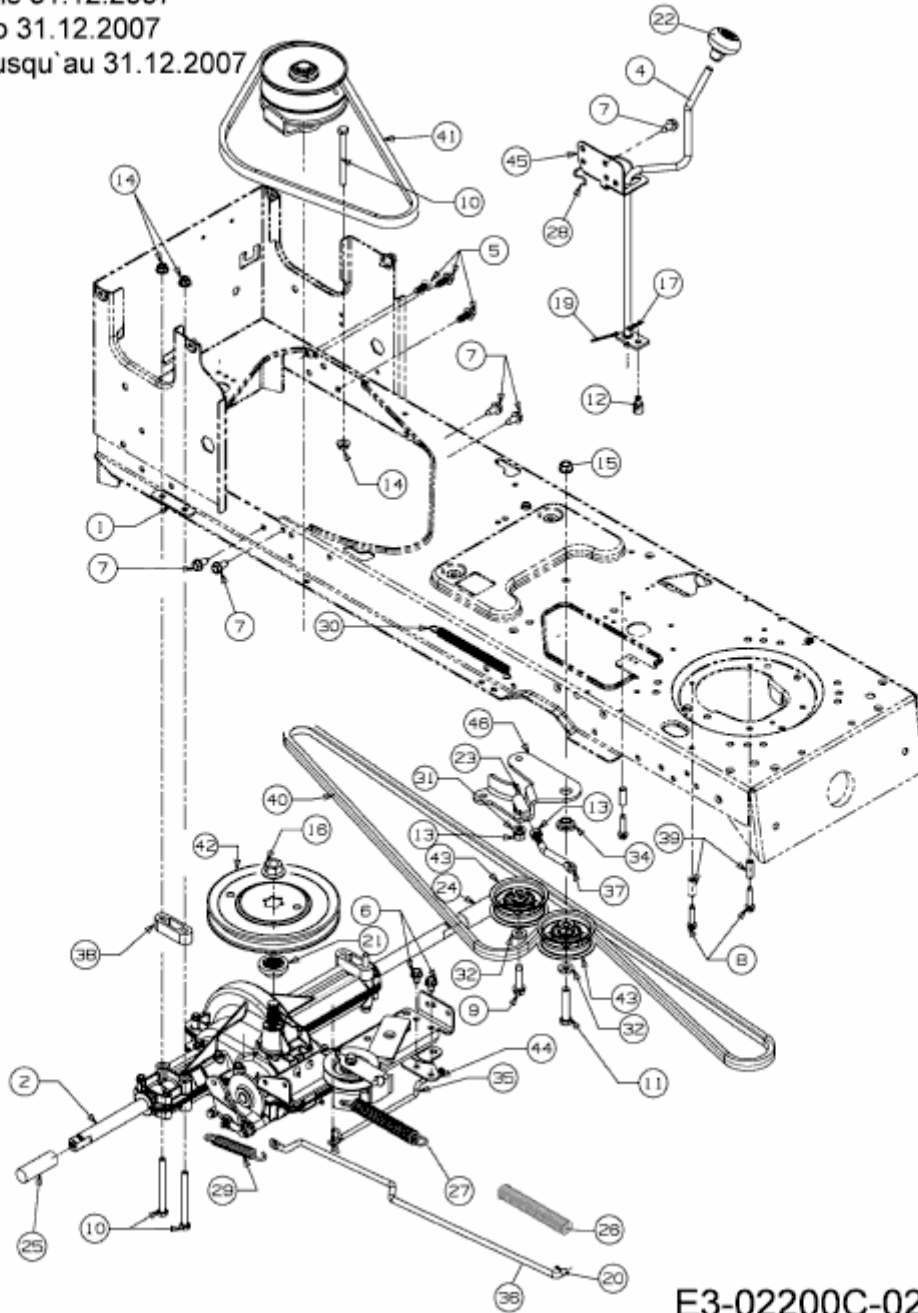

E3-02200C-02