

GLX 105 RH > 13AV51GN690 (2009) > MOTORZUBEHÖR

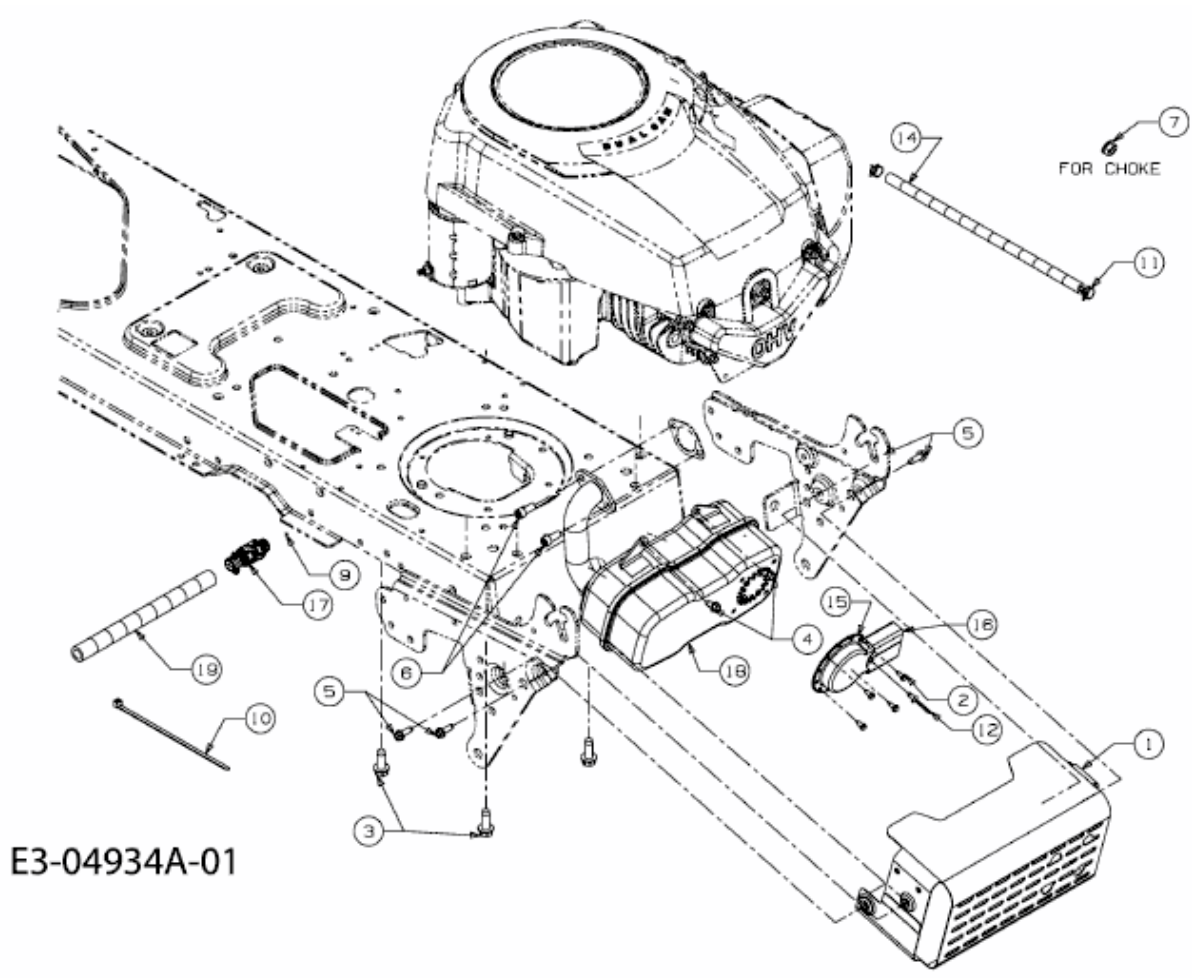

E3-04934A-01