

GLX 105 RH > 13AV51GN690 (2009) > MÄHWERKSEINSCHALTUNG

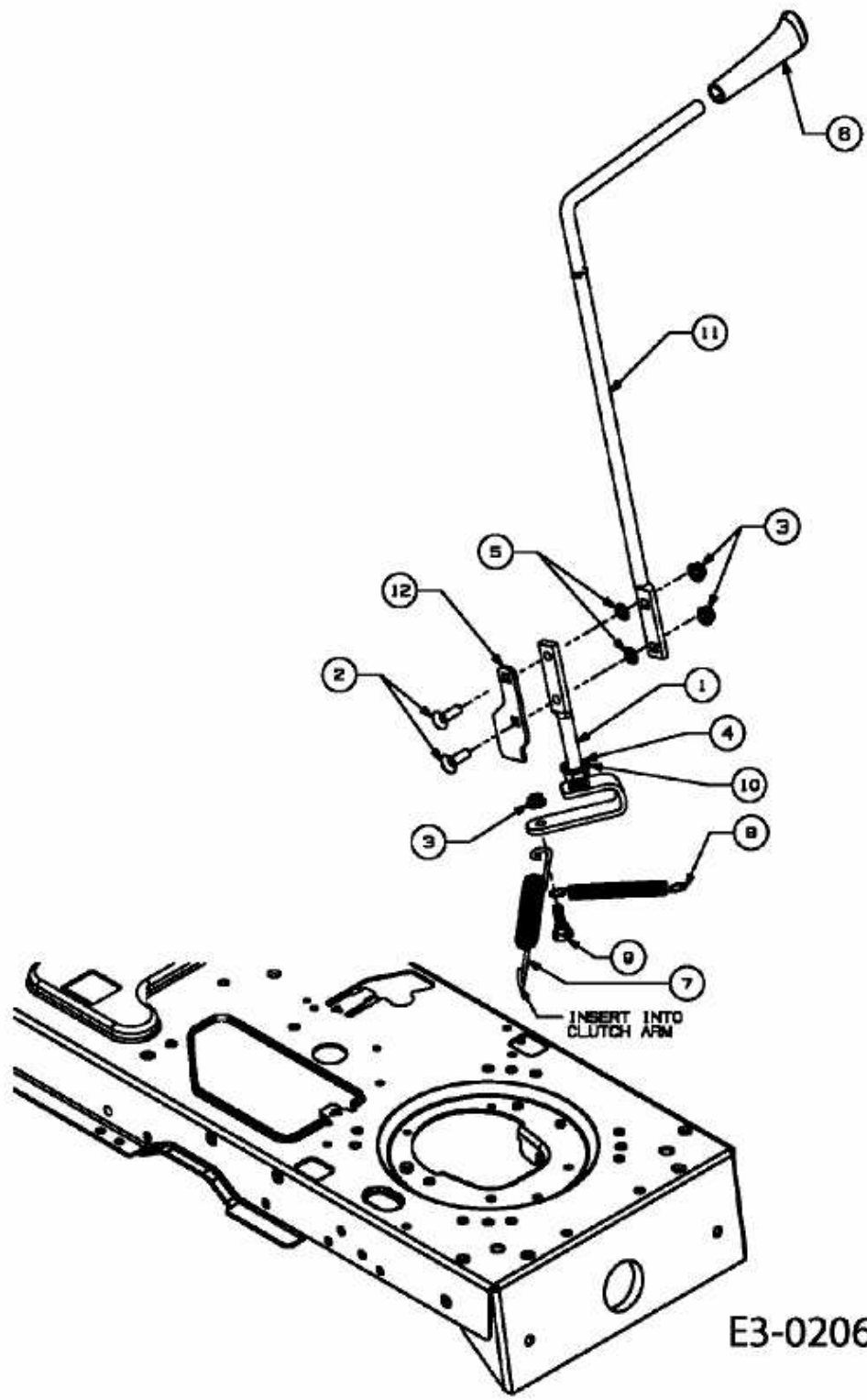

E3-02062B-01