

GLX 105 RH > 13AV51GN690 (2009) > SITZWANNE

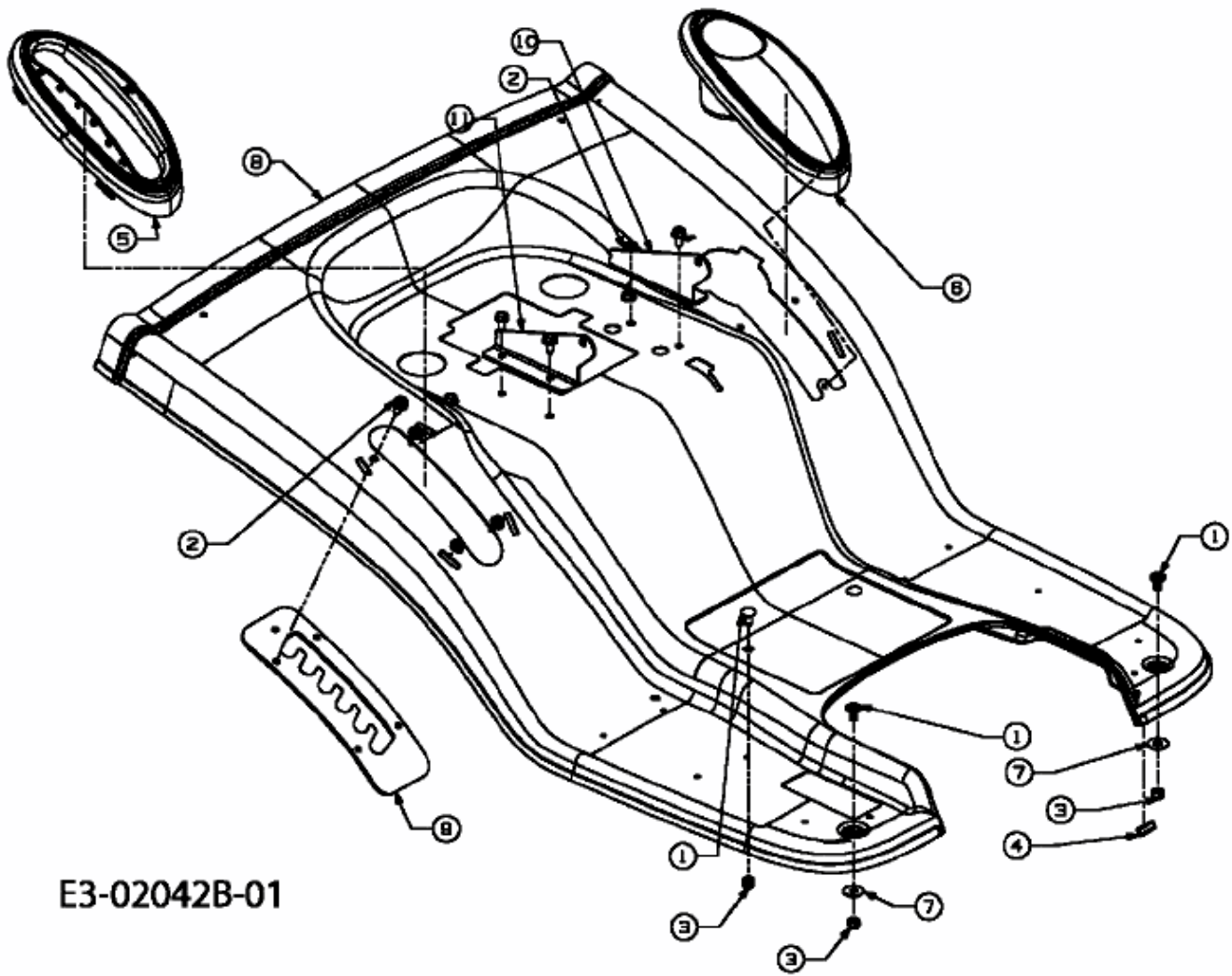

E3-02042B-01