

GLX 105 RH > 13AV51GN690 (2009) > SITZTRÄGER

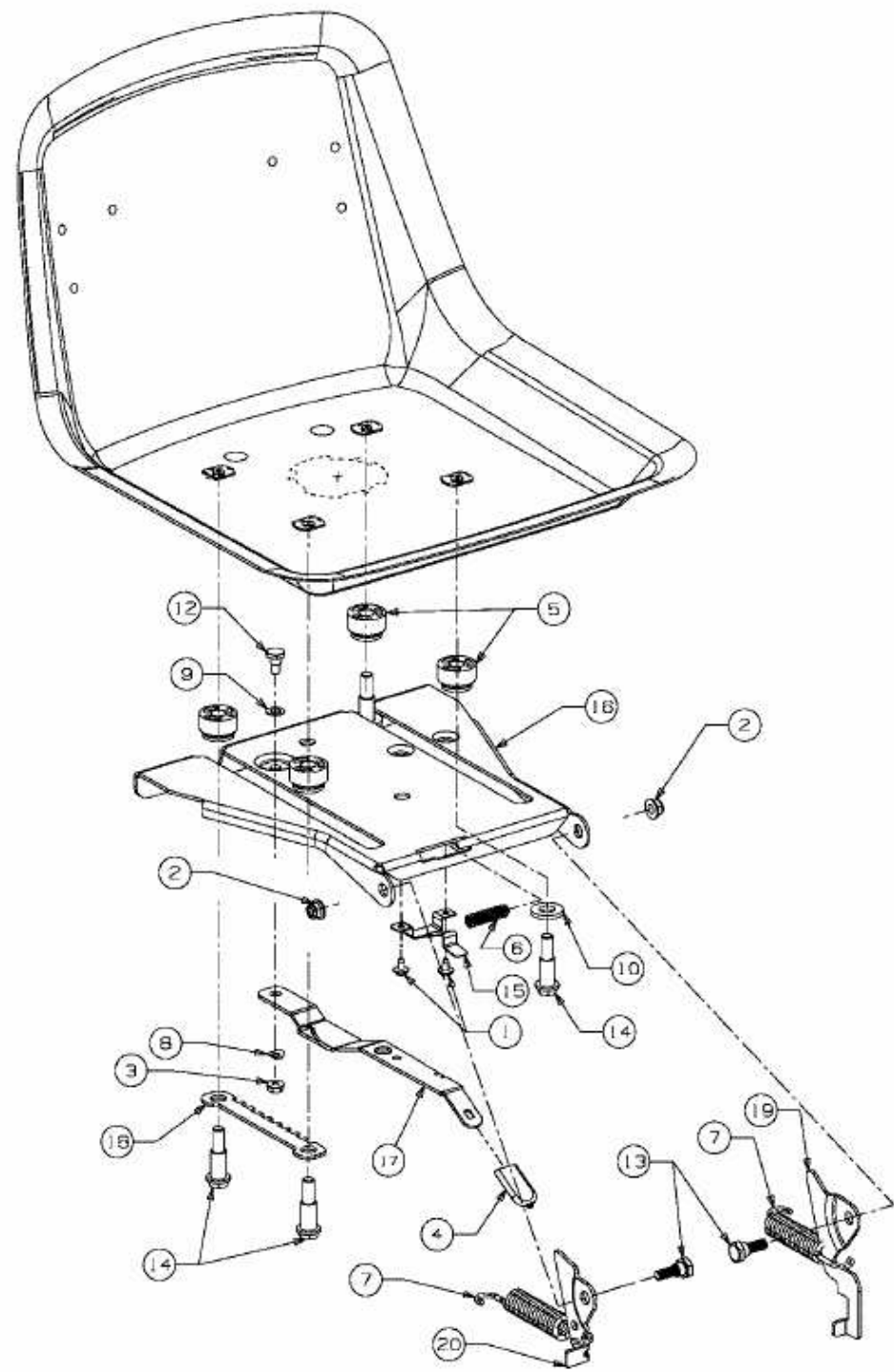

E3-02342B-01