

bis 27.11.2006
to 27.11.2006
jusqu'au 27.11.2006

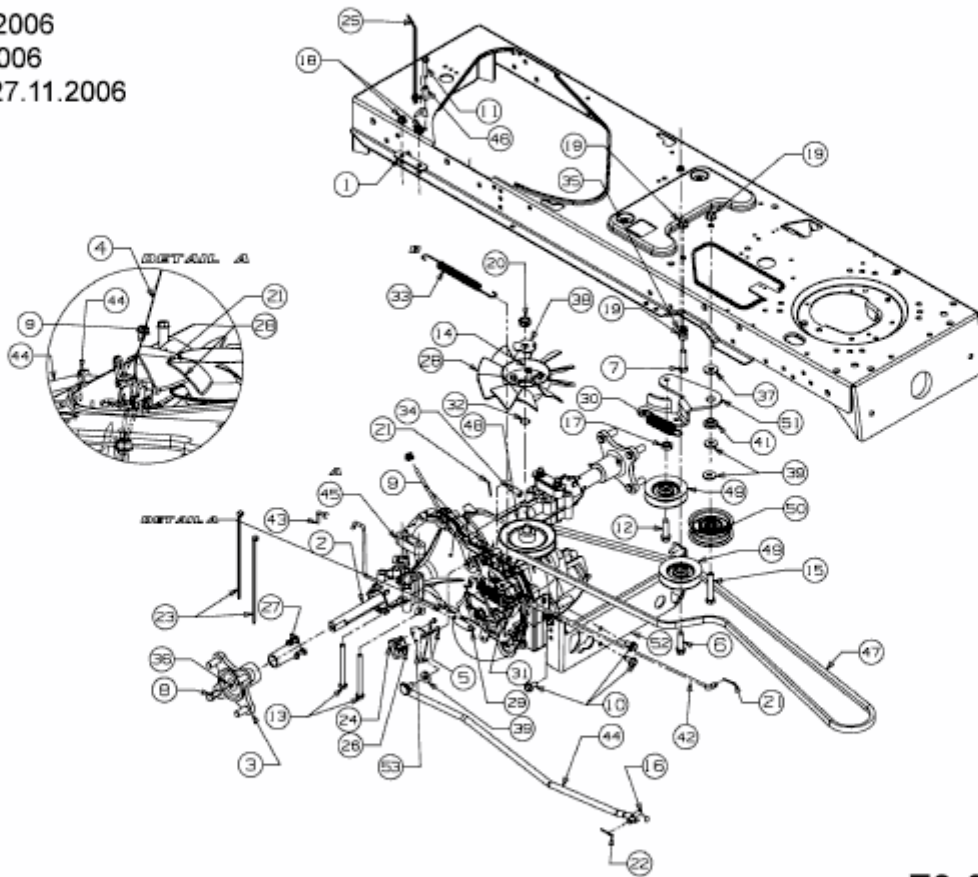

E3-03084A-02