

272-105 TWINH > 13AU997N615 (2013) > AUSGLEICHSBEHÄLTER, HYDROSTAT

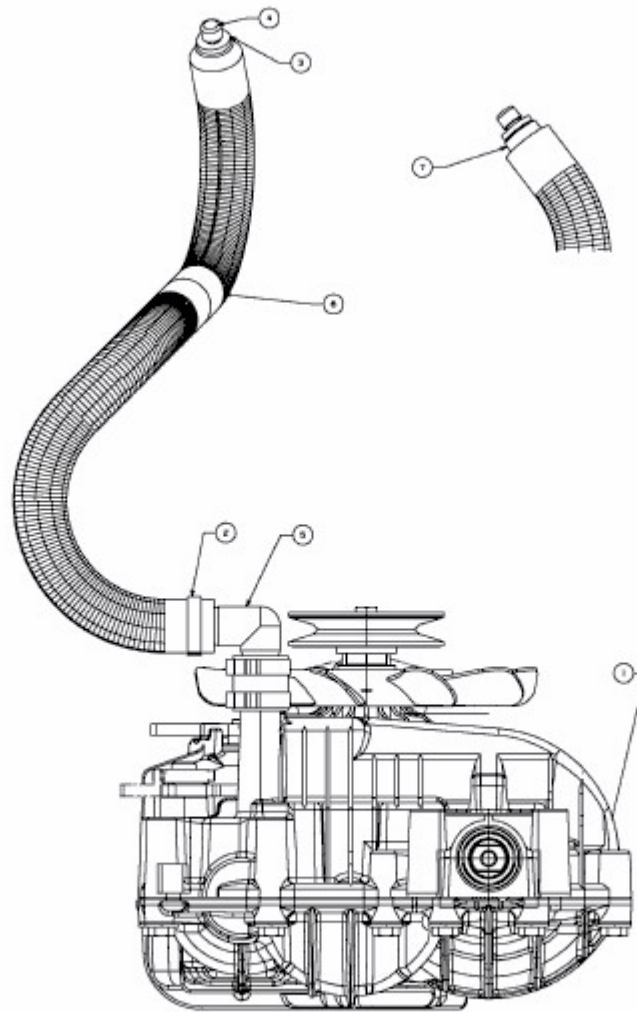

E3-07522A-02