

RANGER 3 (22/105 H) > 13AU718N661 (2011) > ARMATURENBRETT

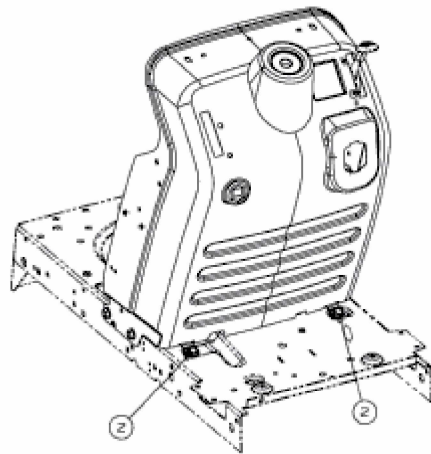
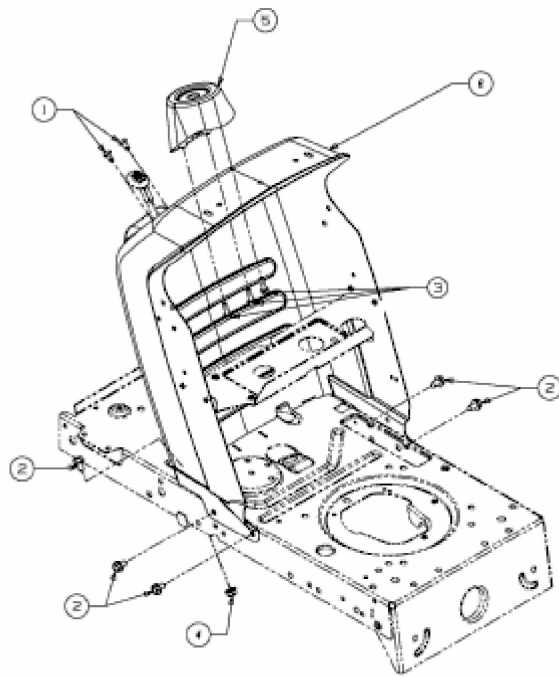

E3-02734D-01