

bis 12.01.2009  
to 12.01.2009  
jusqu'au 12.01.2009

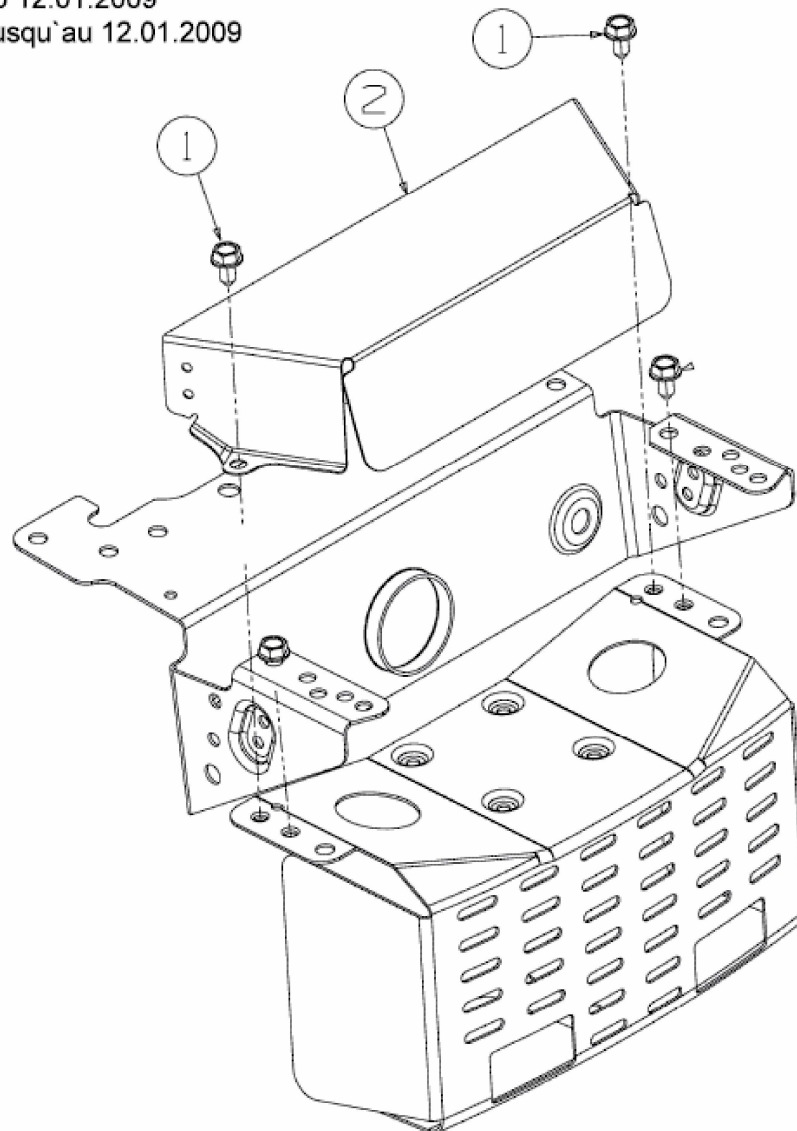

E3-03552A-02