

STORM 108/20 H > 13AT79KG637 (2010) > CHOKEZUG

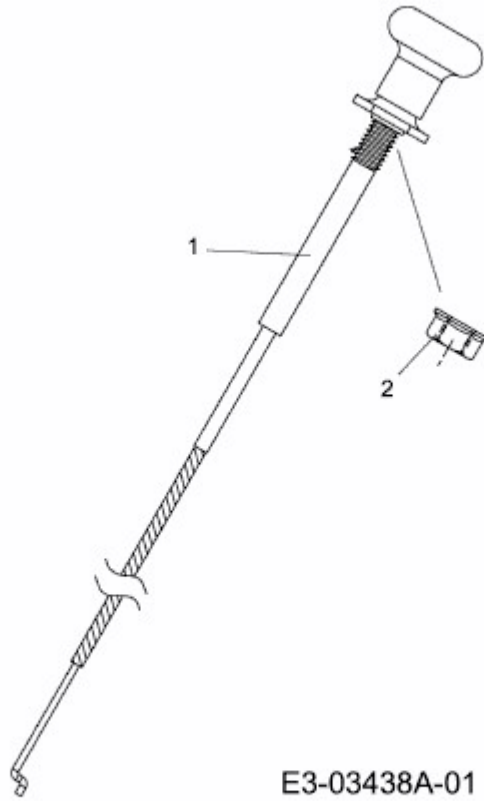

E3-03438A-01