

ab 11.12.2008
from 11.12.2008
à partir du 11.12.2008

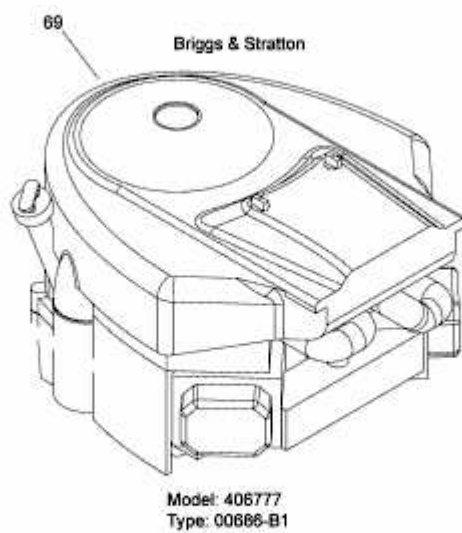

E3-09485A-01