

P 180 HG > 13AT793G678 (2009) > FAHRANTRIEB

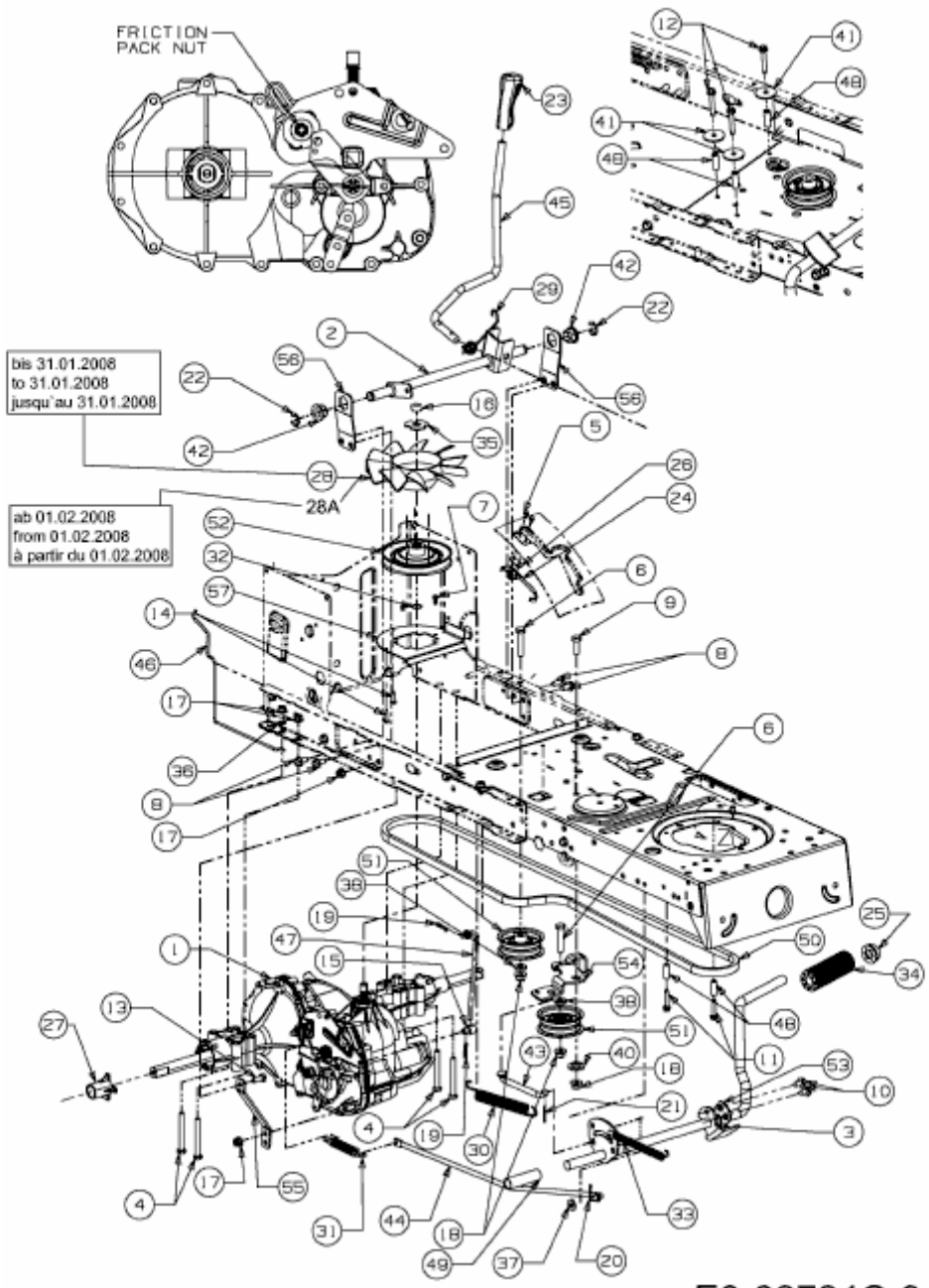

E3-02724C-01