

P 180 HG > 13AT793G678 (2008) > CHOKEZUG

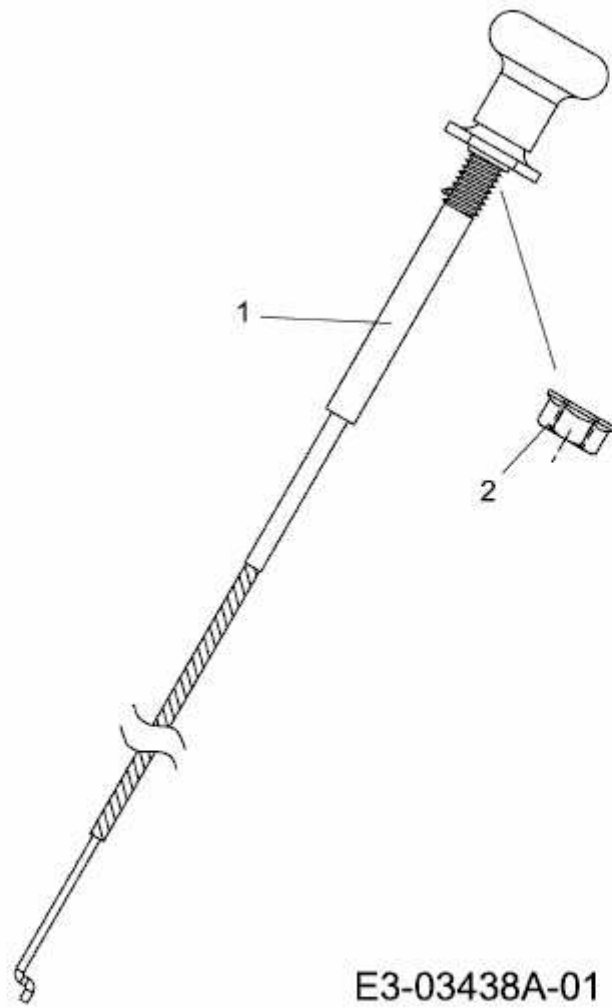

E3-03438A-01