

P 180 HG > 13AT793G678 (2008) > LENKRAD

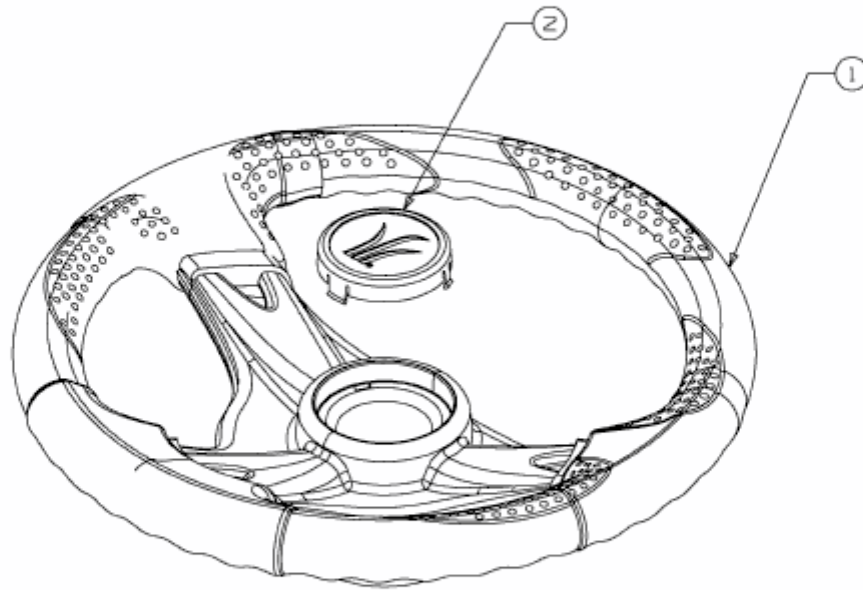

E3-02712A-01