

180-107 > 13AT777G615 (2010) > MÄHWERKSEINSCHALTUNG, MOTORKEILRIEMENSCHLEIBE

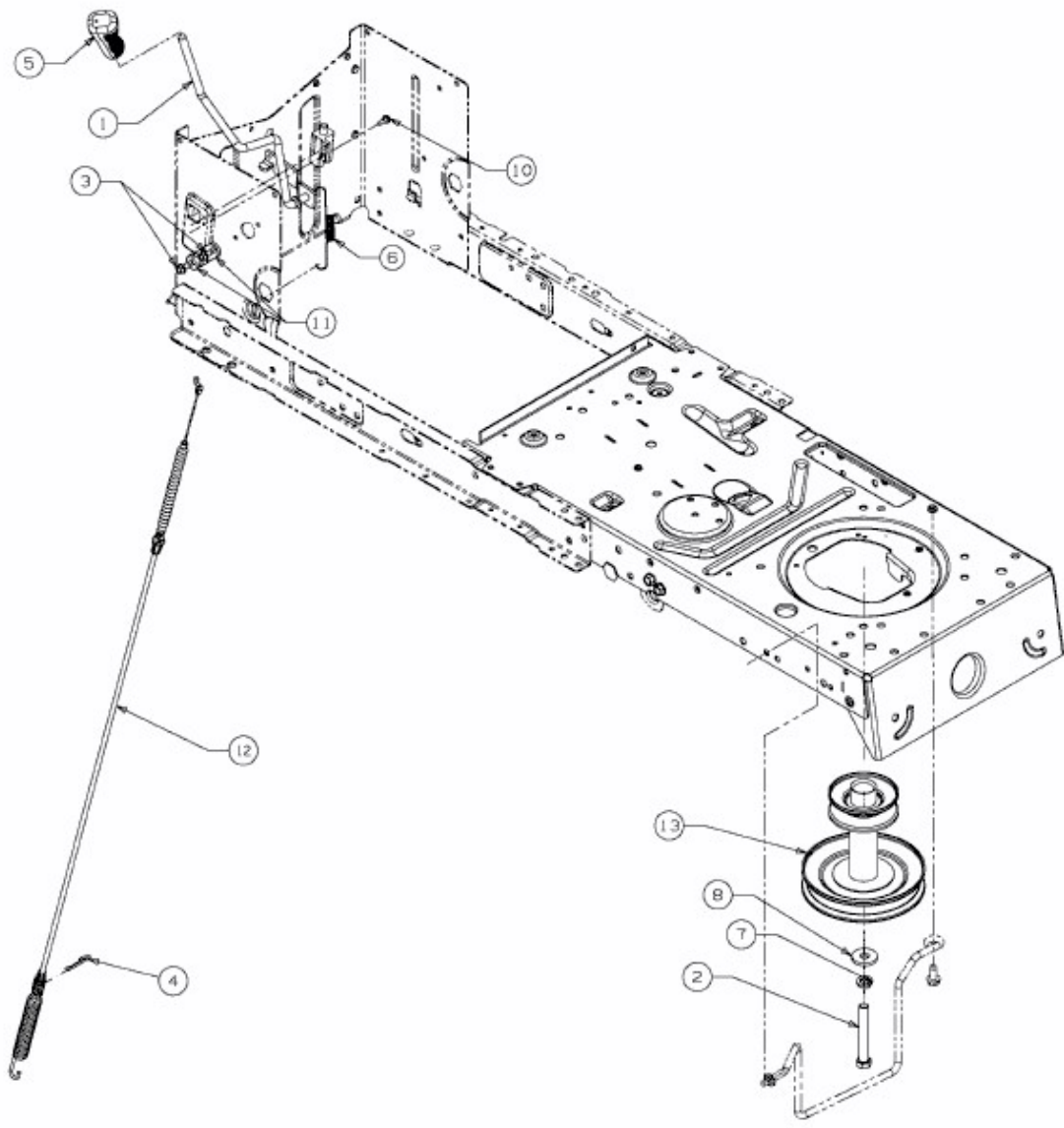

E3-05555A-01