

180-107 > 13AT777G615 (2010) > GETRIEBE, VARIATOR

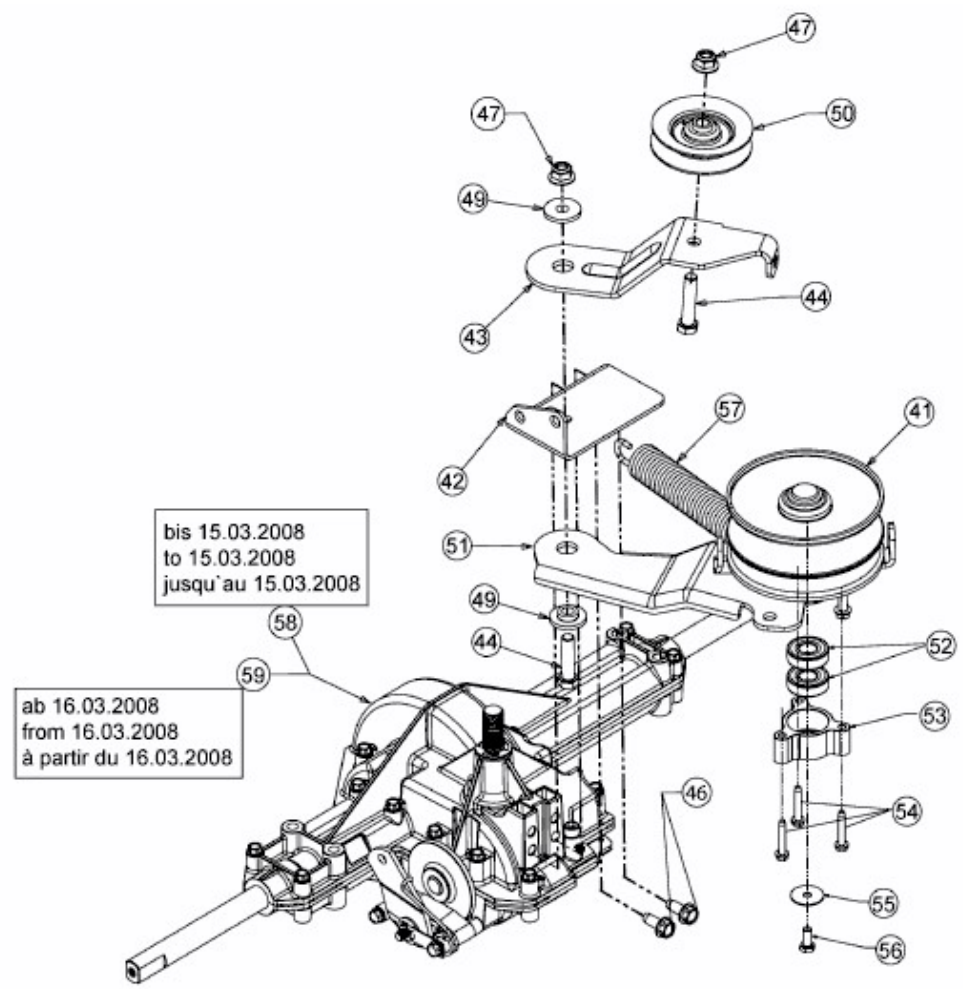

E3-02723C-02