

180-107 > 13AT777G615 (2009) > MÄHWERKSEINSCHALTUNG, MOTORKEILRIEMENSCHLEIBE

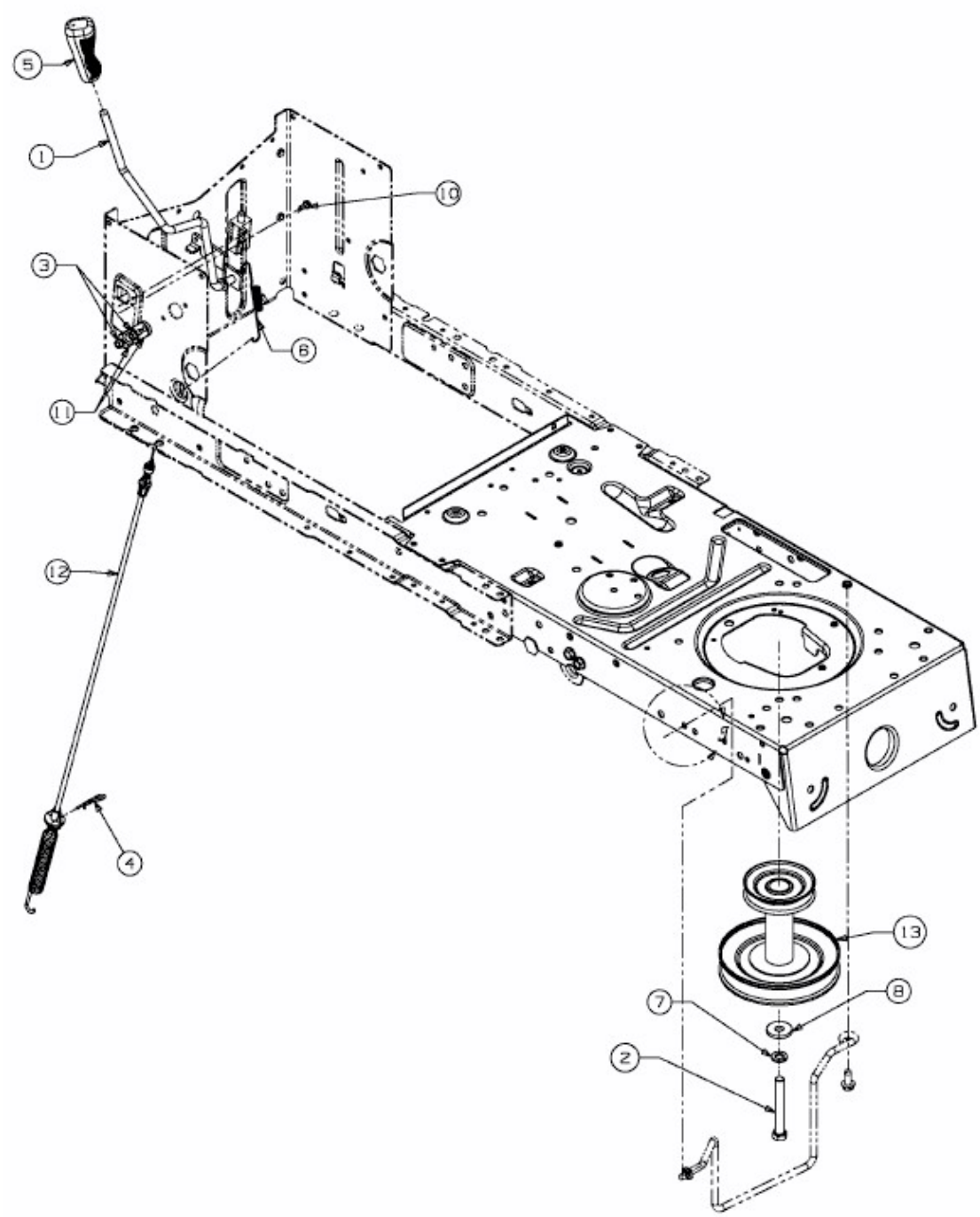

E3-04372A-01