

9

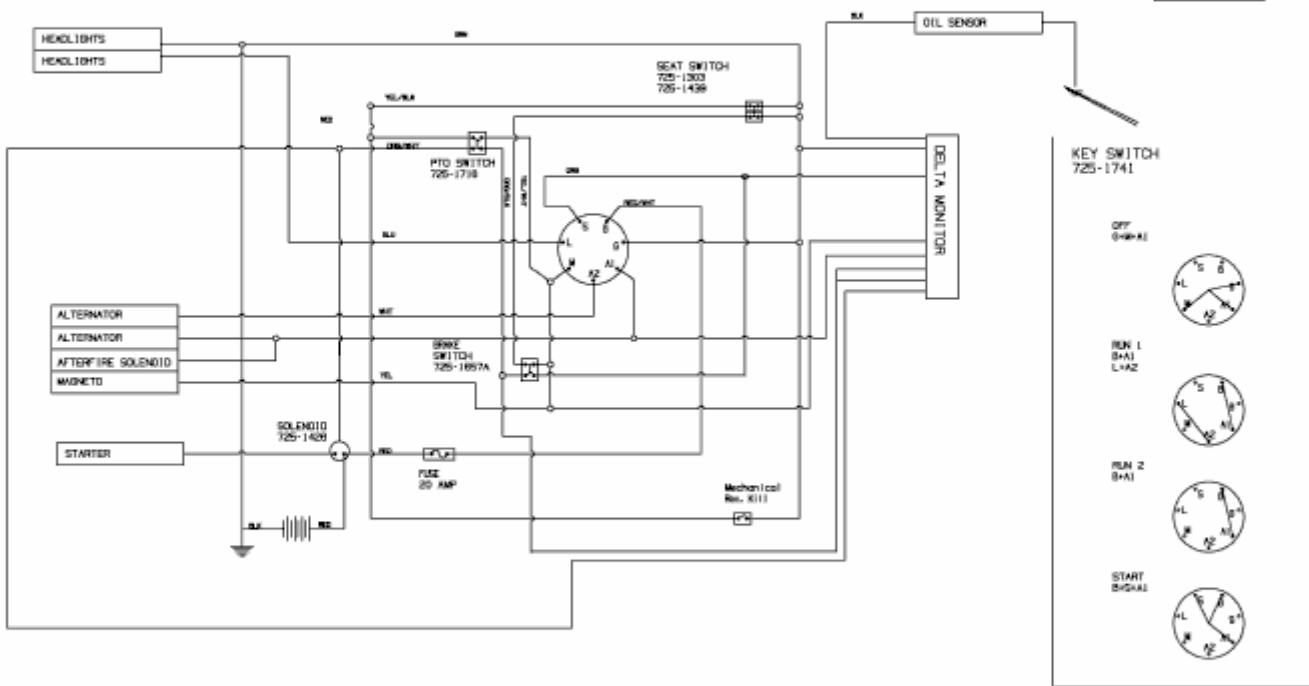

E3-08979A-02