

bis 02.10.2001  
to 02.10.2001  
jusqu'au 02.10.2001

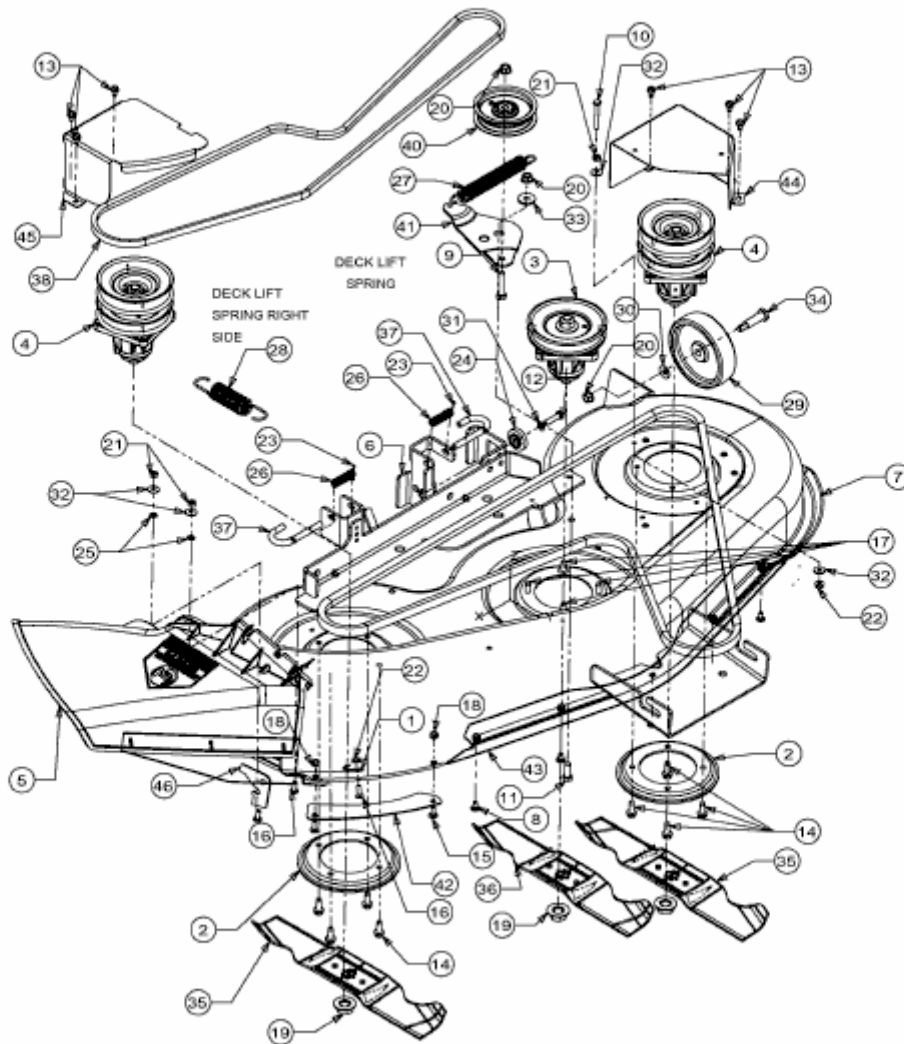

E3-07911A-01