

EP 180/105 > 13AT489N608 (2005) > RAHMEN

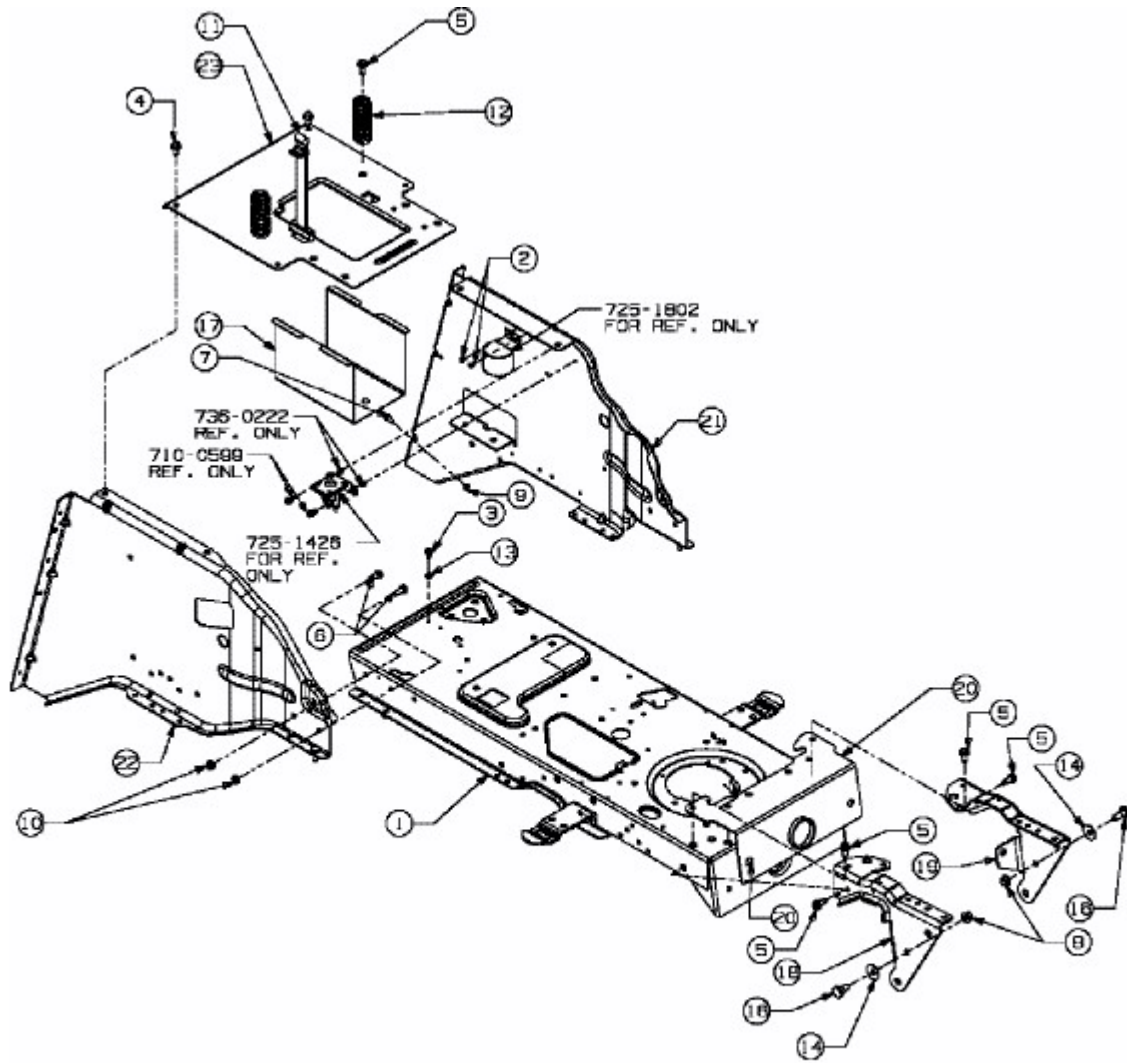

E3-02026A-01