

[XT 2 QR 106](#) > [13AQA1CR330 \(2017\)](#) >
[Elektromagnetkupplung, Motorkeilriemenscheibe](#)

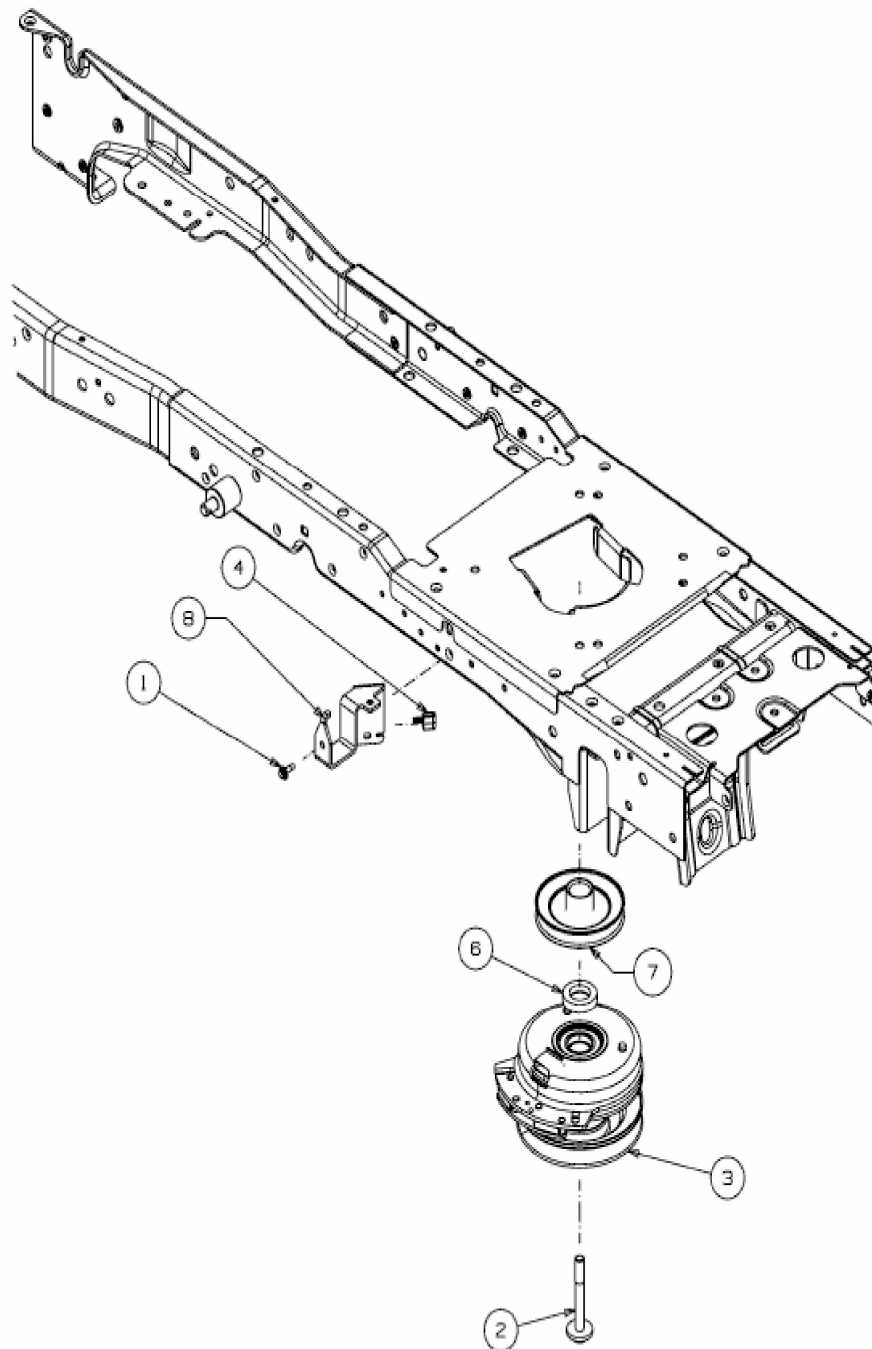

E3-10081A-01