

ab 24.01.2015  
from 24.01.2015  
à partir du 24.01.2015

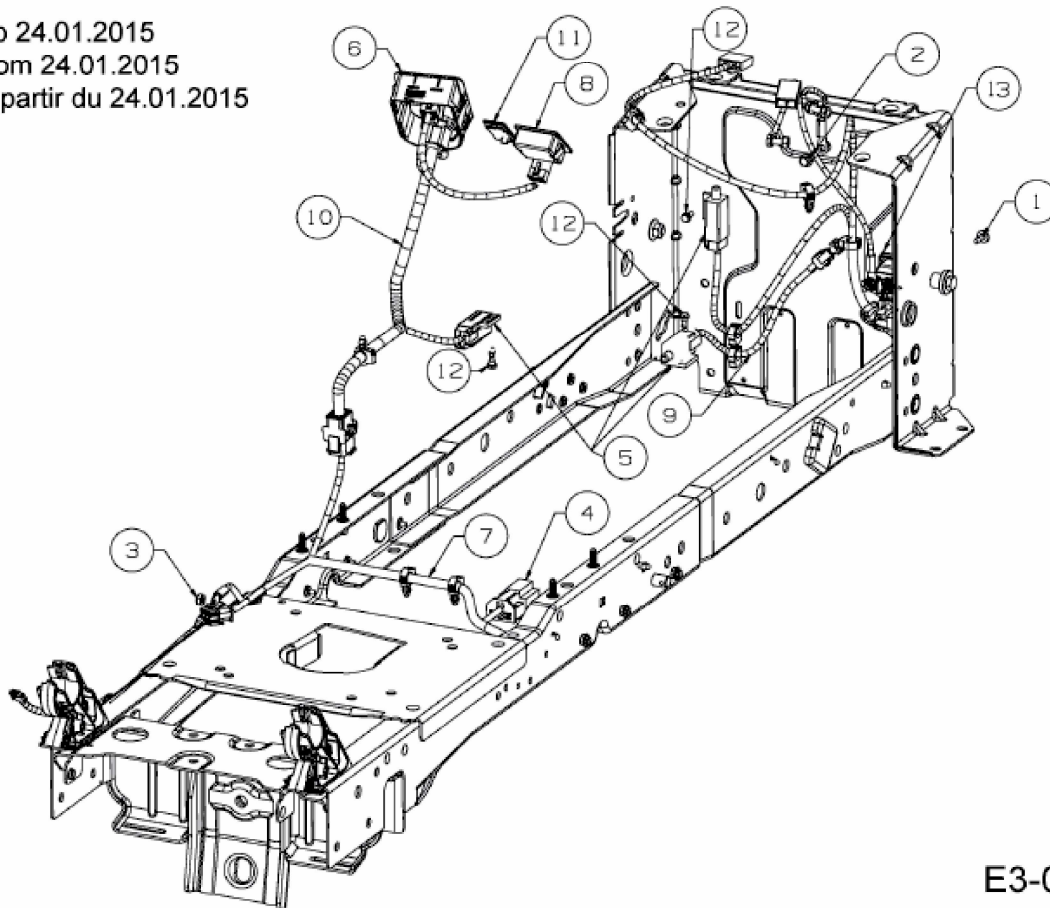

E3-09205A-91