

ab 28.01.2015
from 28.01.2015
à partir du 28.01.2015

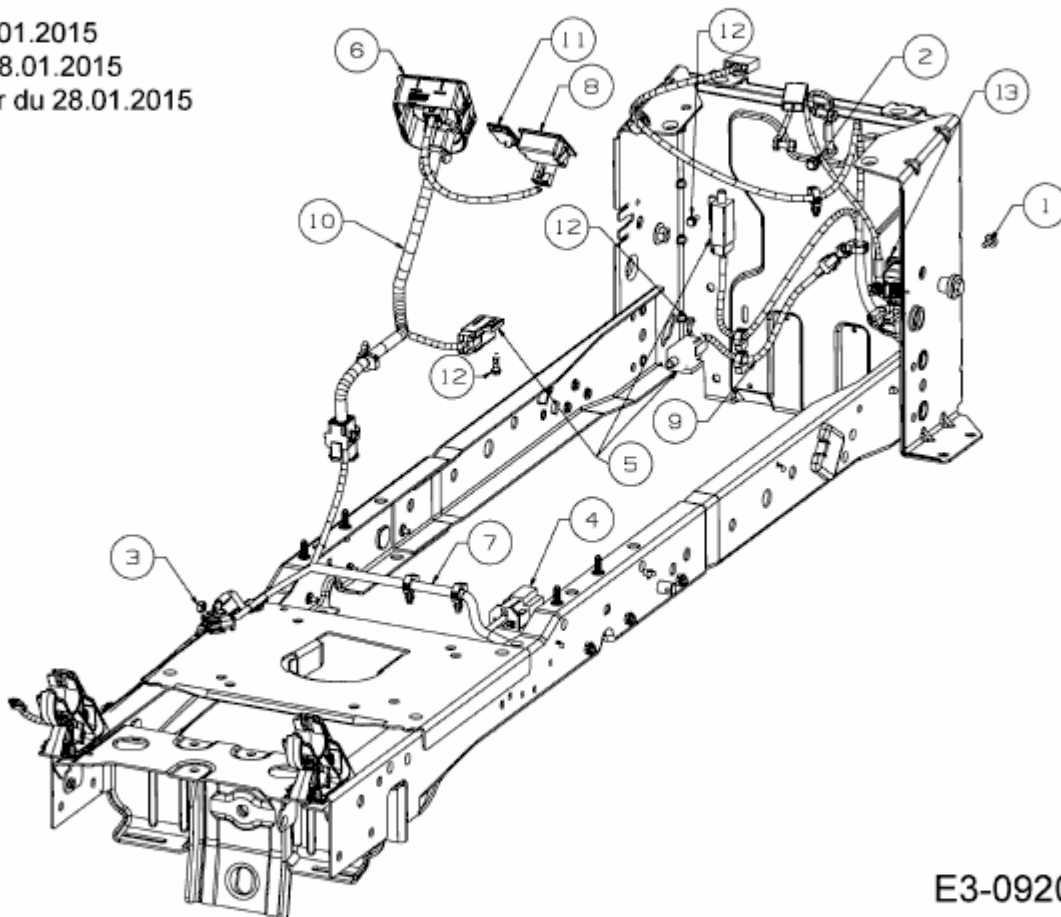

E3-09205A-01