

ab 28.01.2015
from 28.01.2015
jusqu'au 28.01.2015

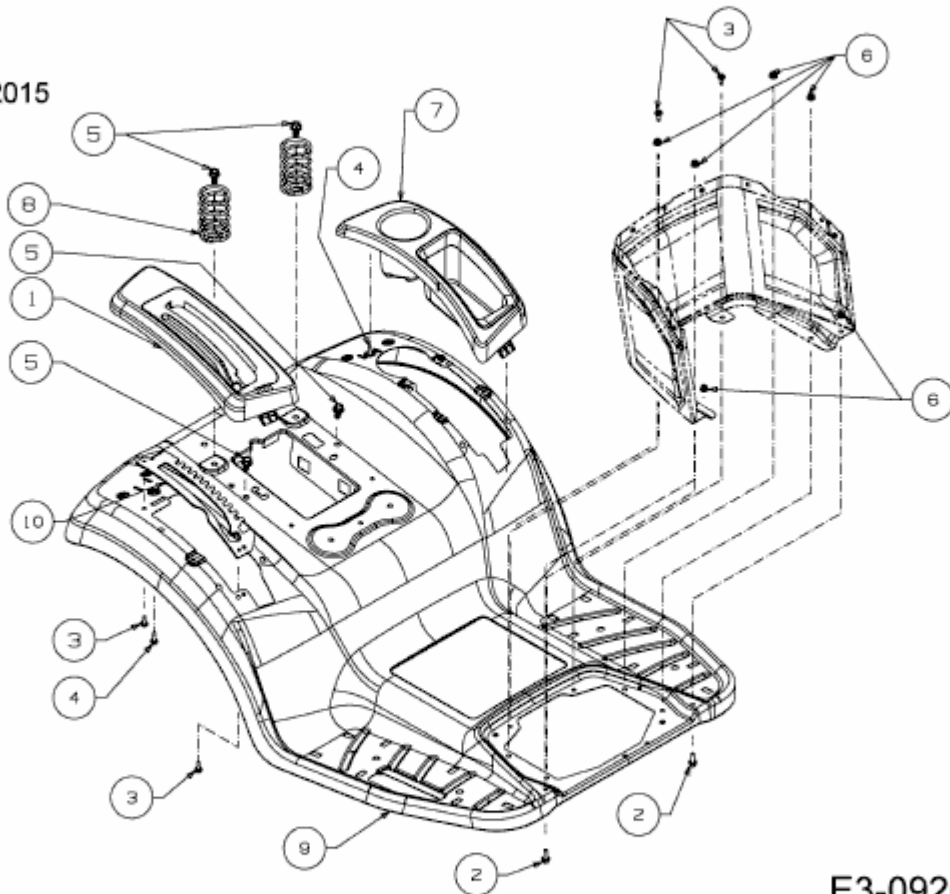

E3-09202A-01