

1

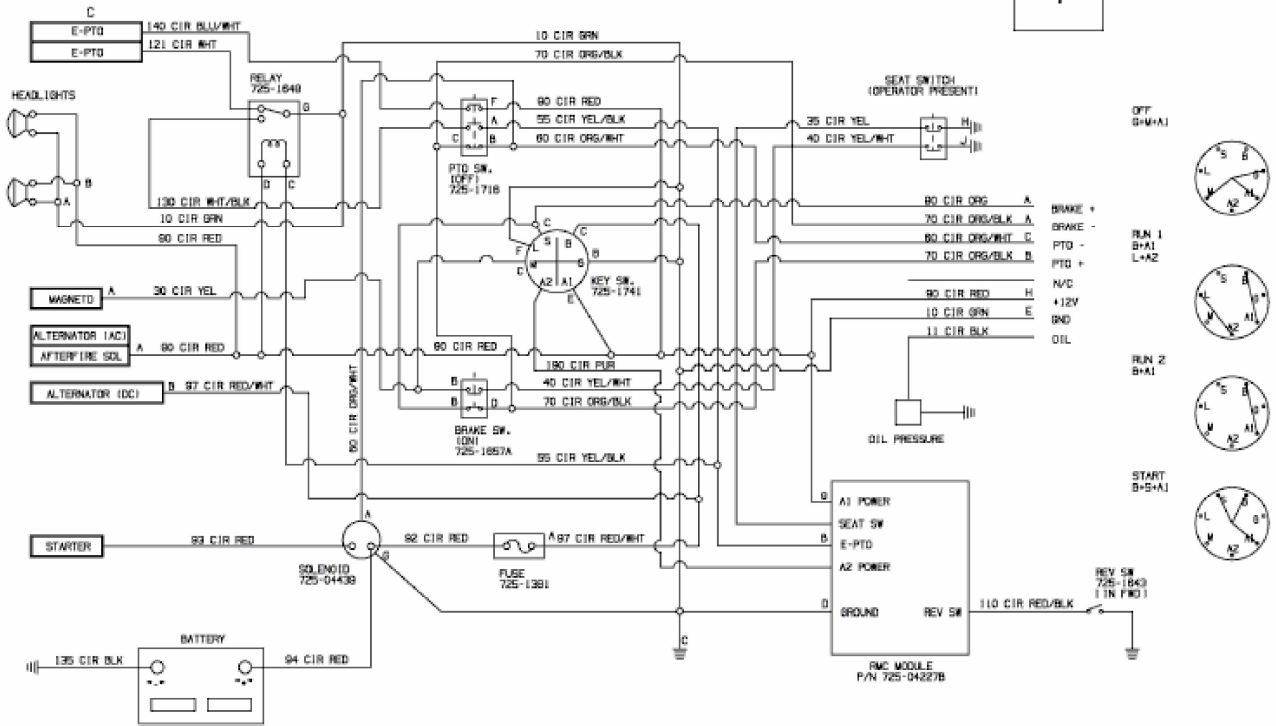

E3-02896A-02