

1

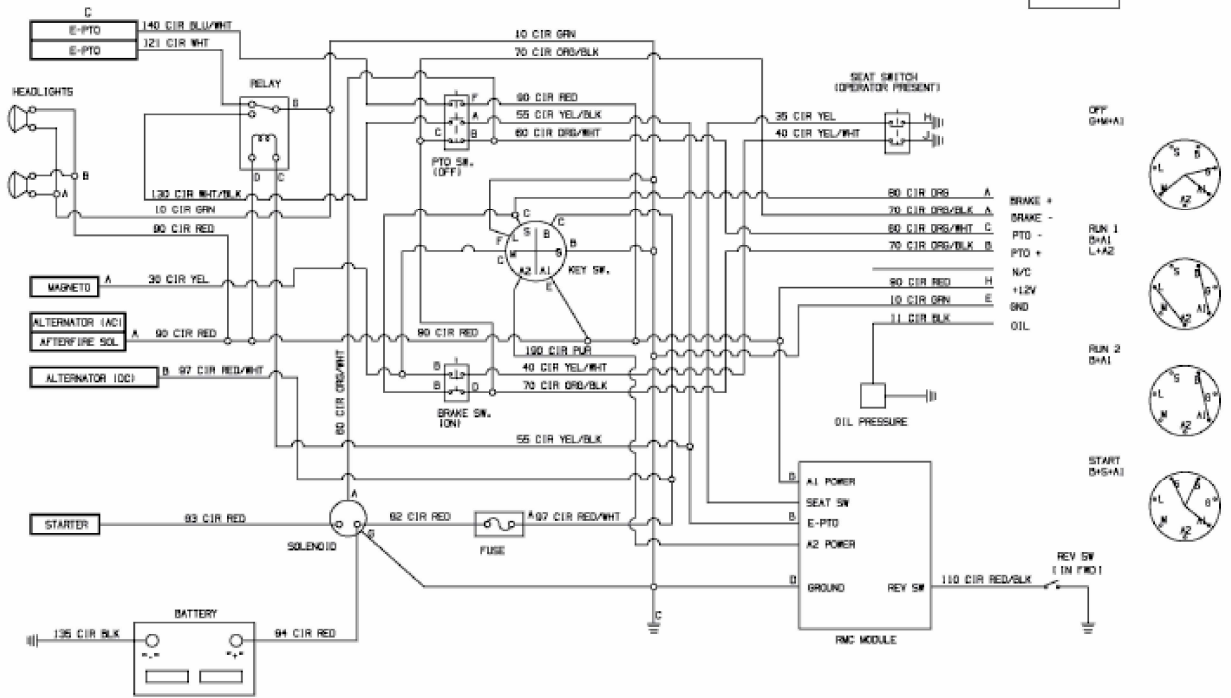

E3-08535A-02