

9

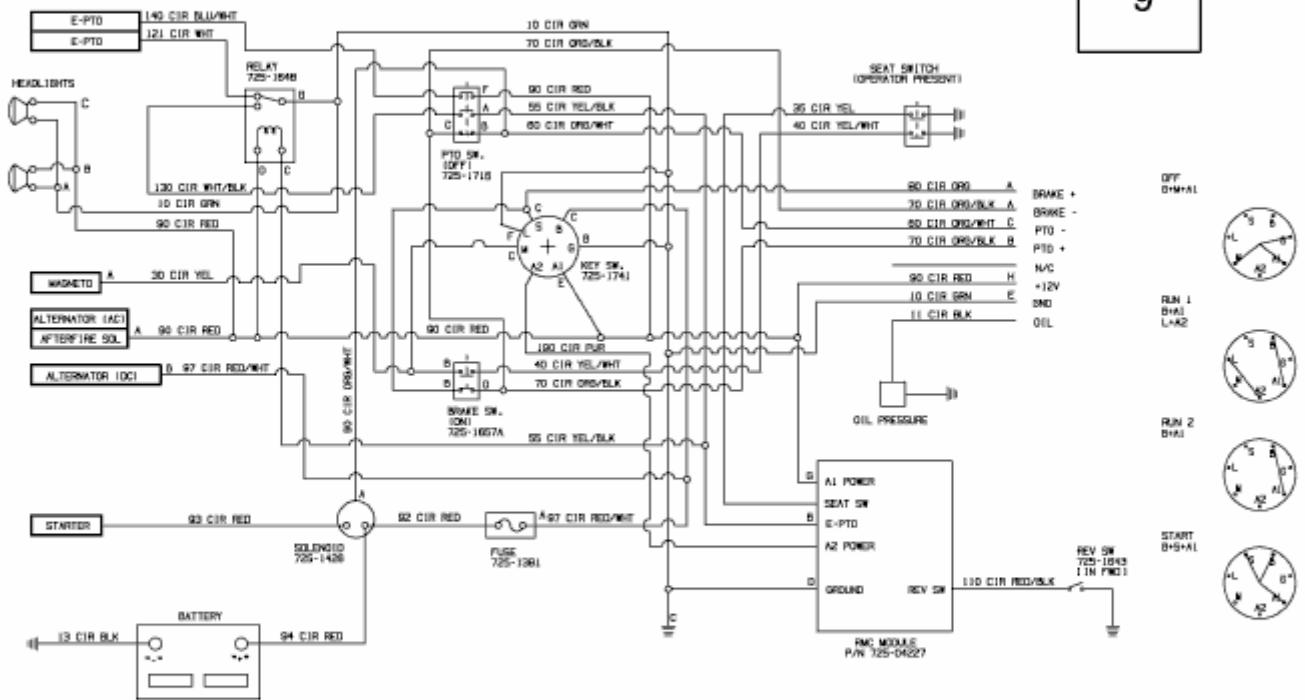

E3-02913A-02