

SN 170 A > 13AP518N678 (2002) > MÄHWERKSAUSHEBUNG

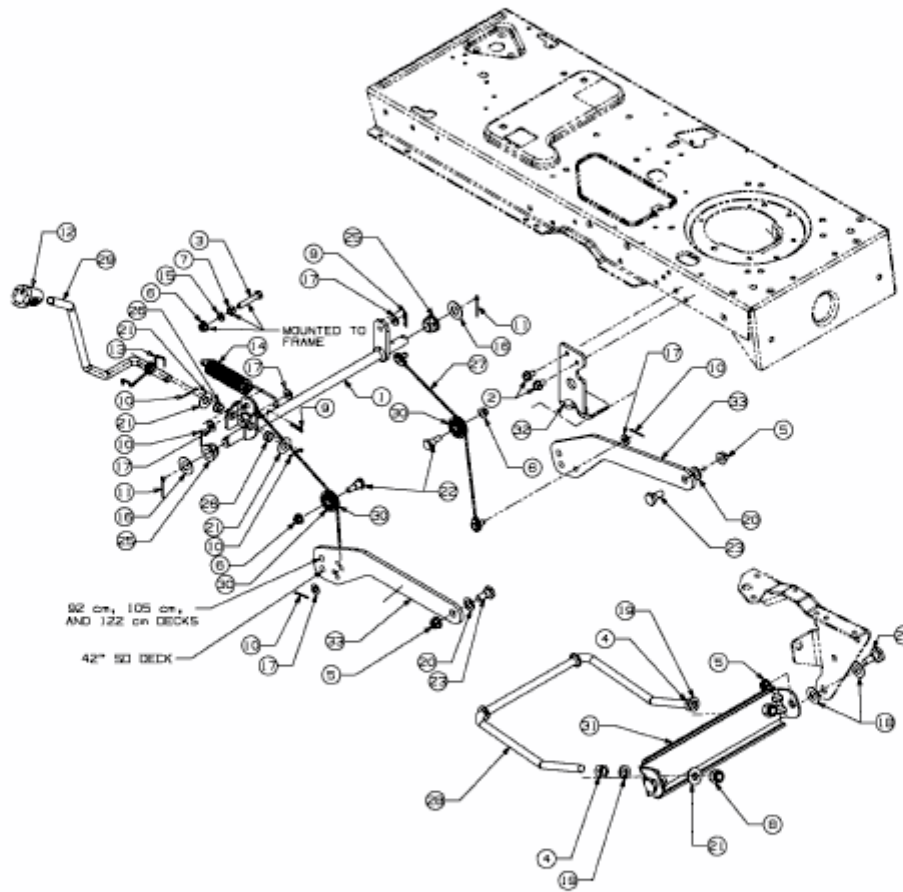

E3-01641B-01