

SN 170 A > 13AP518N678 (2002) > SITZWANNE

500er Serie
Fender , Hydro ,Rear Discharge

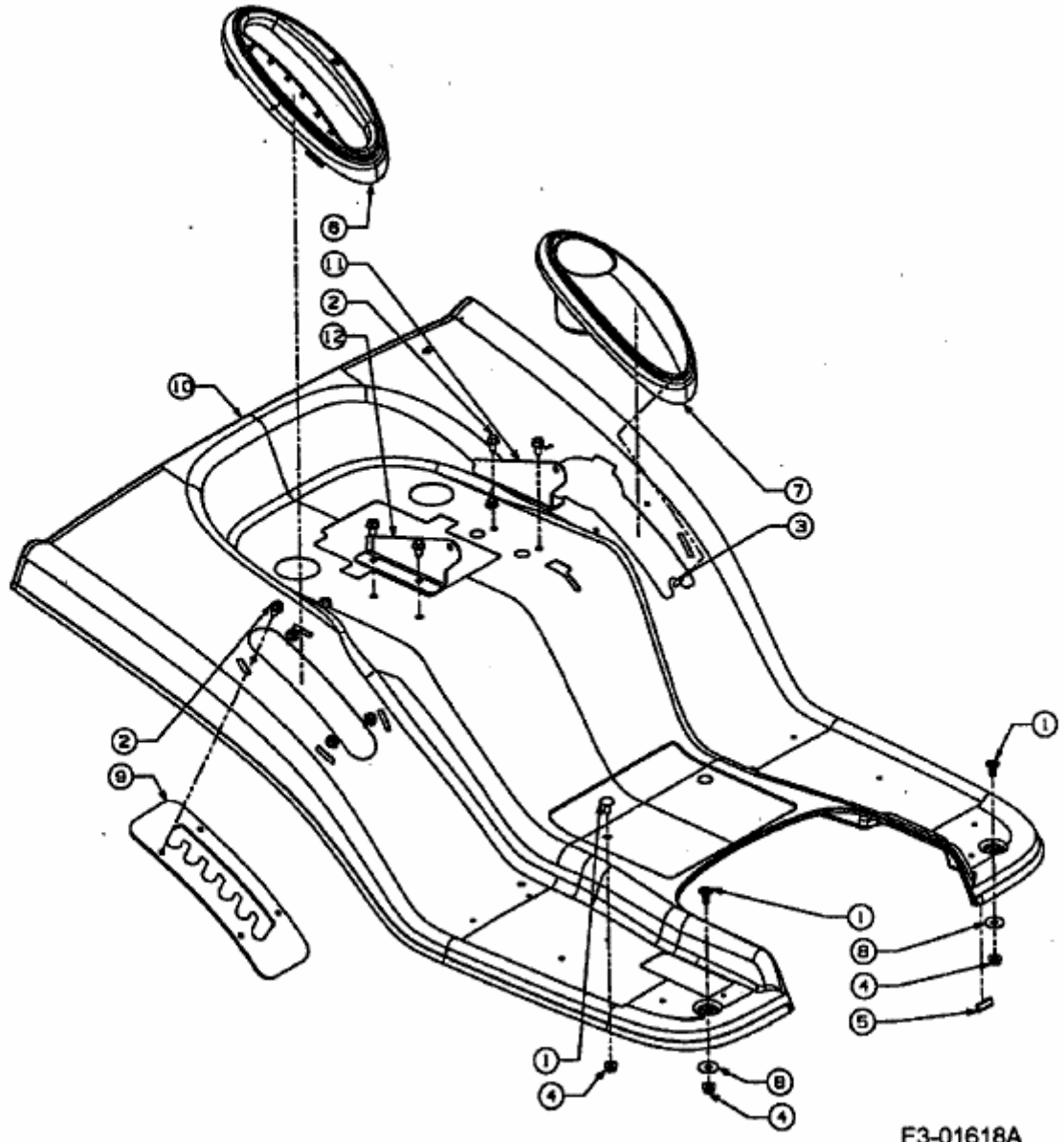

E3-01618A