

SN 170 A > 13AP518N678 (2002) > FAHRANTRIEB

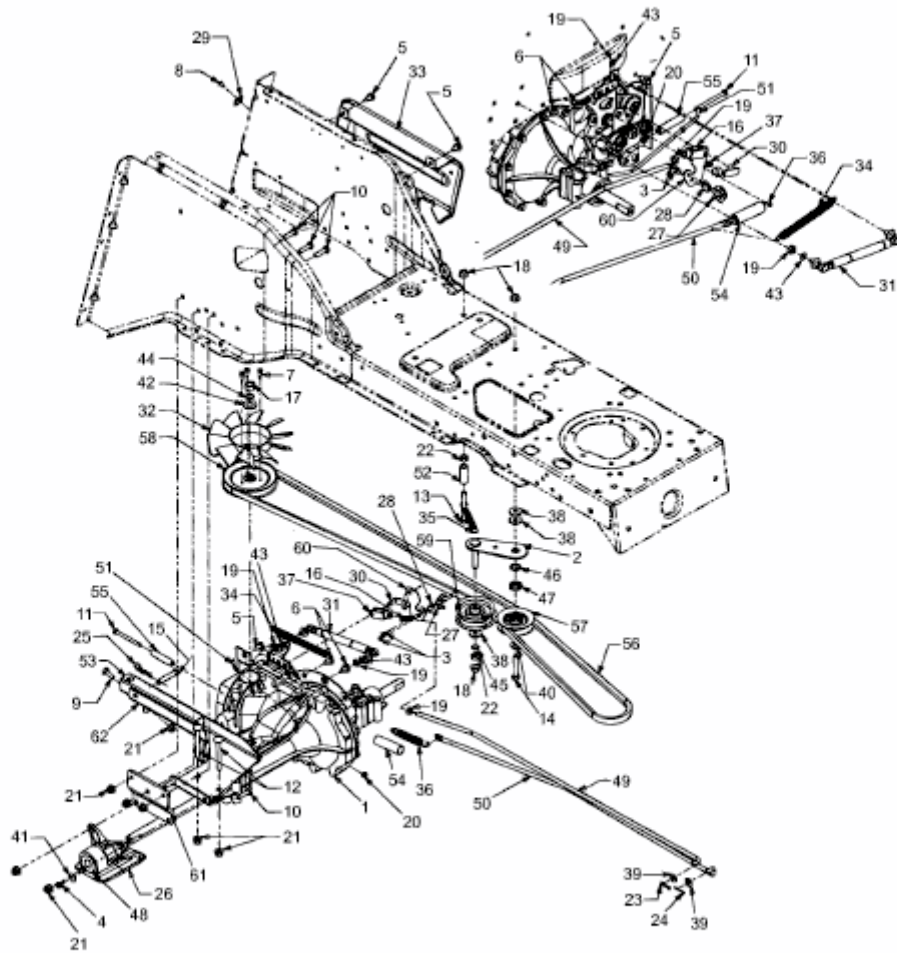

E3-01652C-01