

SN 155 H > 13AP518N678 (2002) > MOTORKEILRIEMENSCHLEIBE

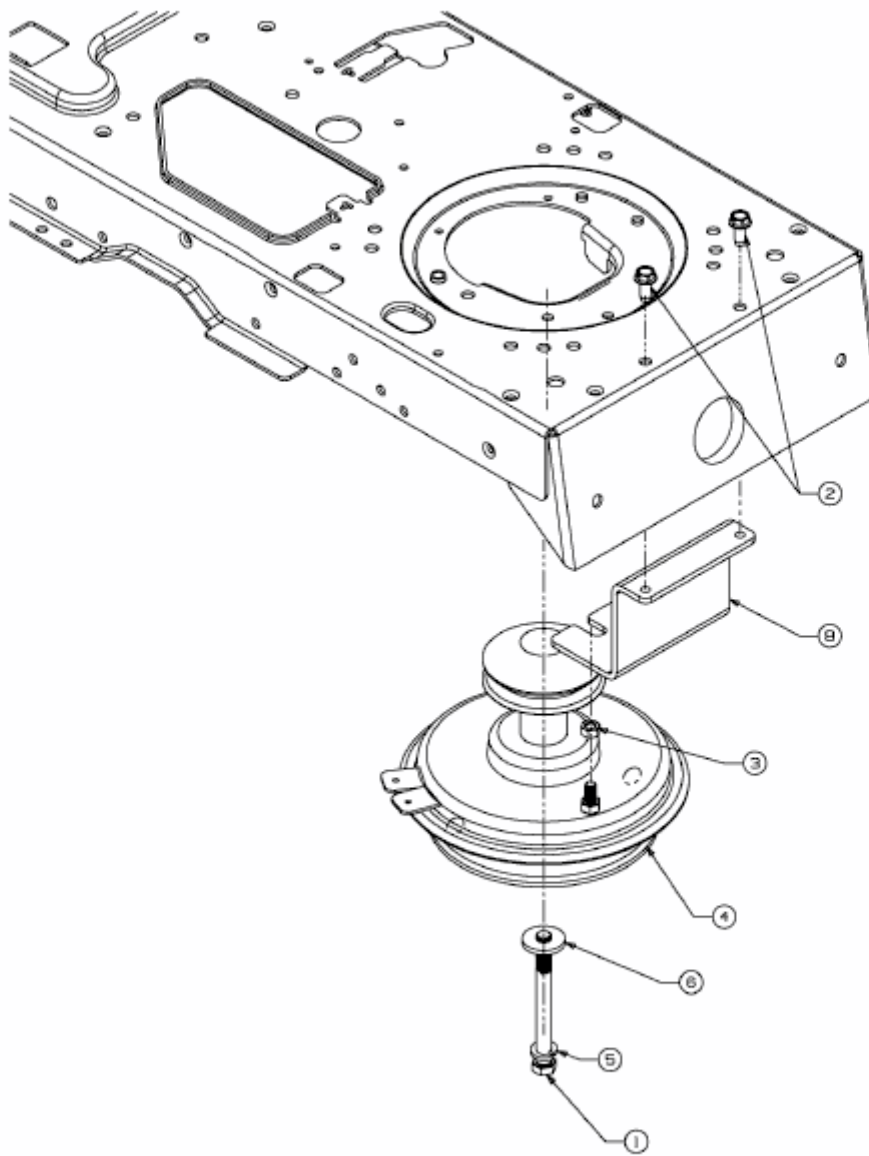

E3-07977A-01