

SN 155 H > 13AP518N678 (2002) > BATTERIE

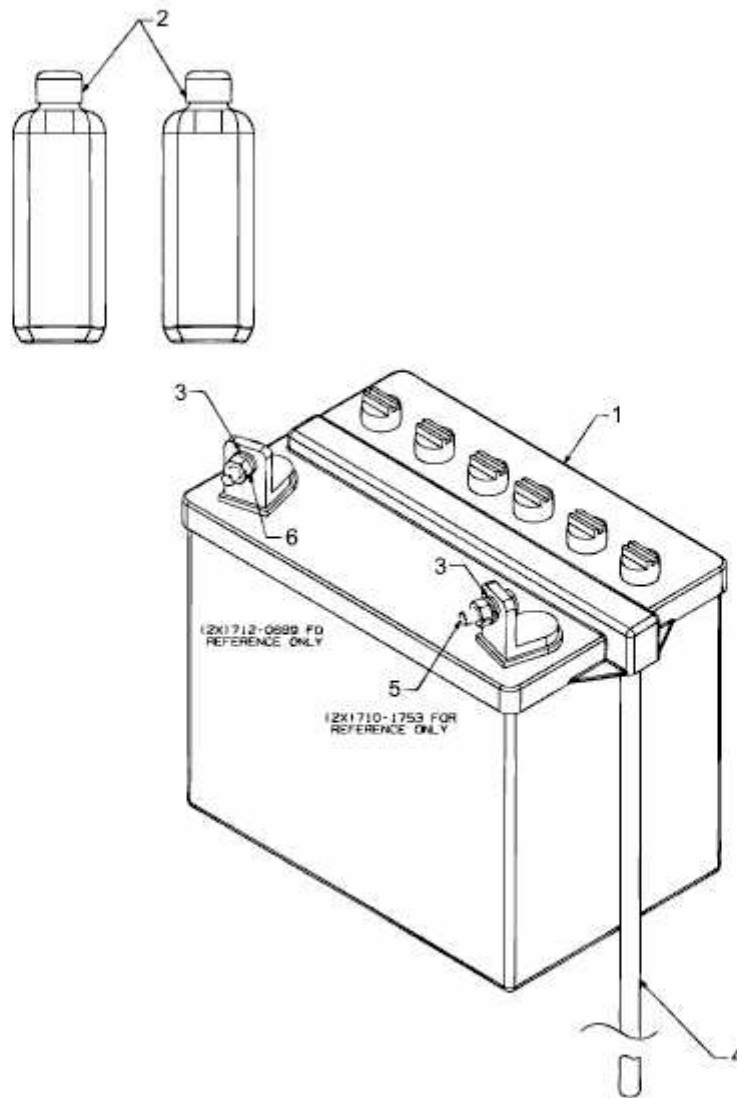

E3-07963A-01