

SN 155 H > 13AP518N678 (2002) > SITZTRÄGER

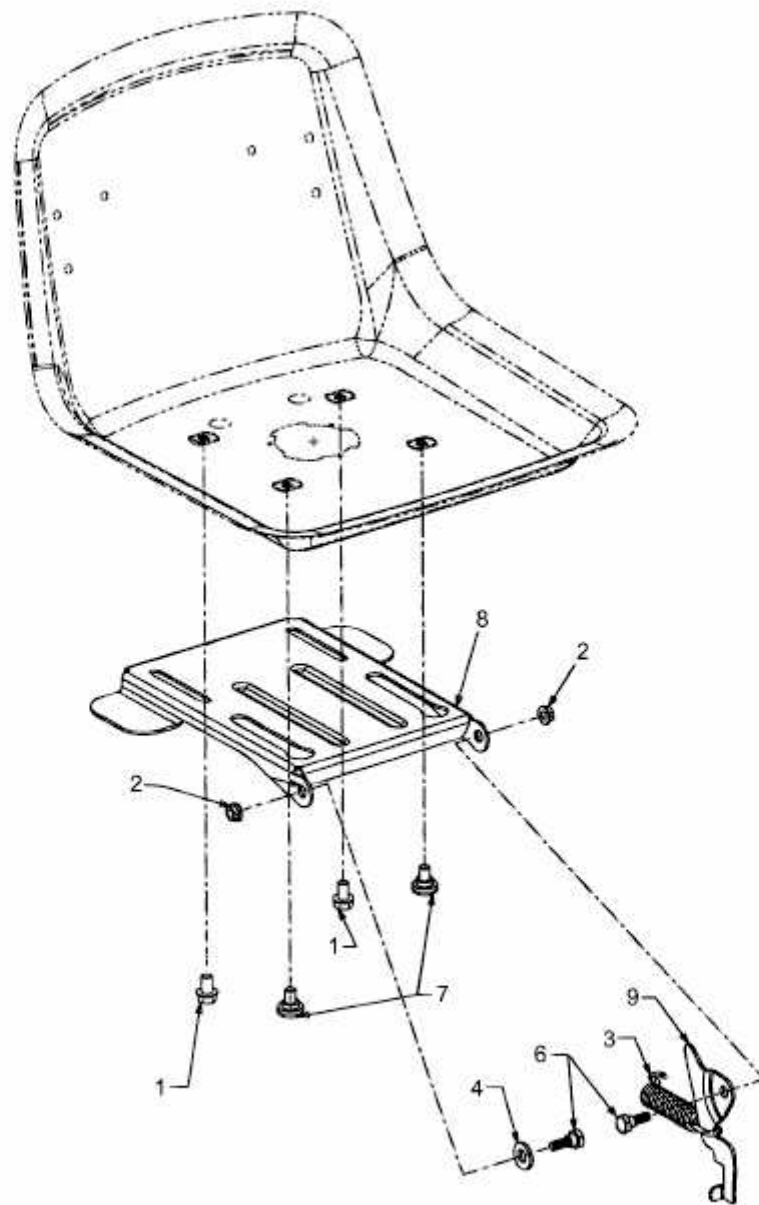

E3-01709A-02