

SN 155 H > 13AP518N678 (2002) > MOTORHAUBE 8-STYLE

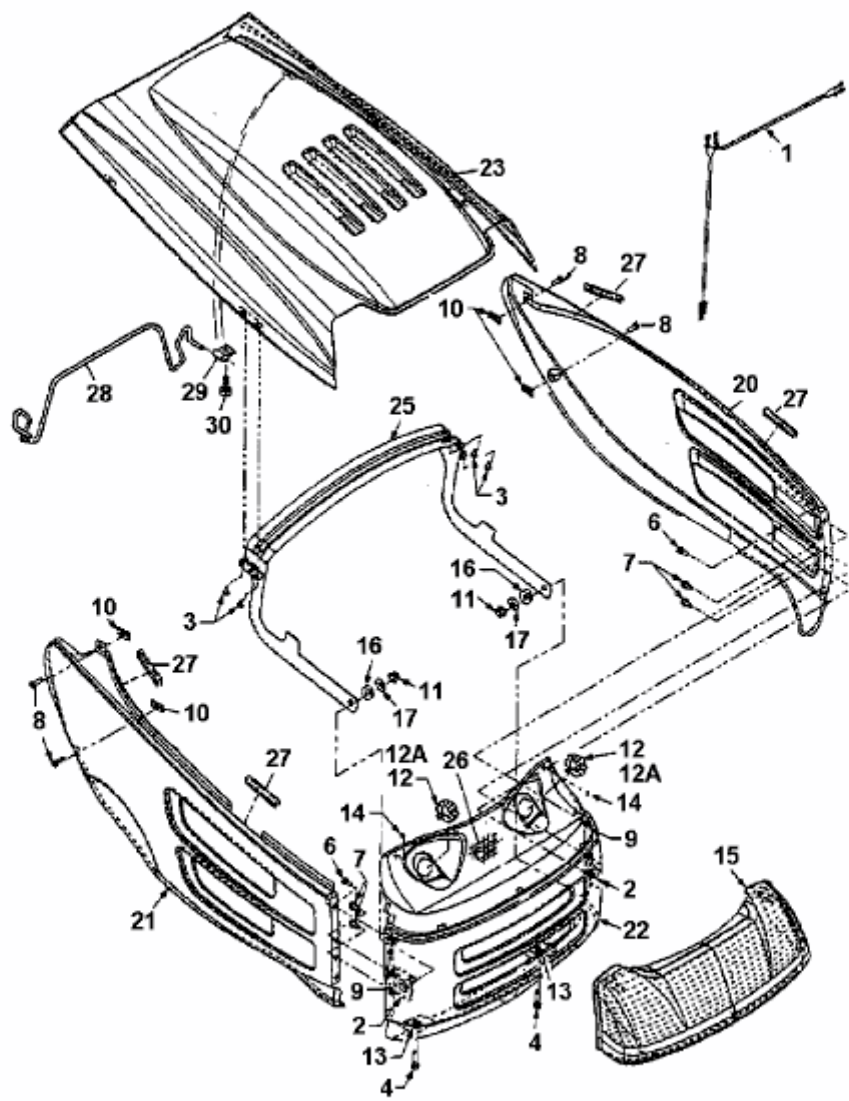

fsg