

SN 155 H > 13AP518N678 (2002) > ARMATURENBRETT

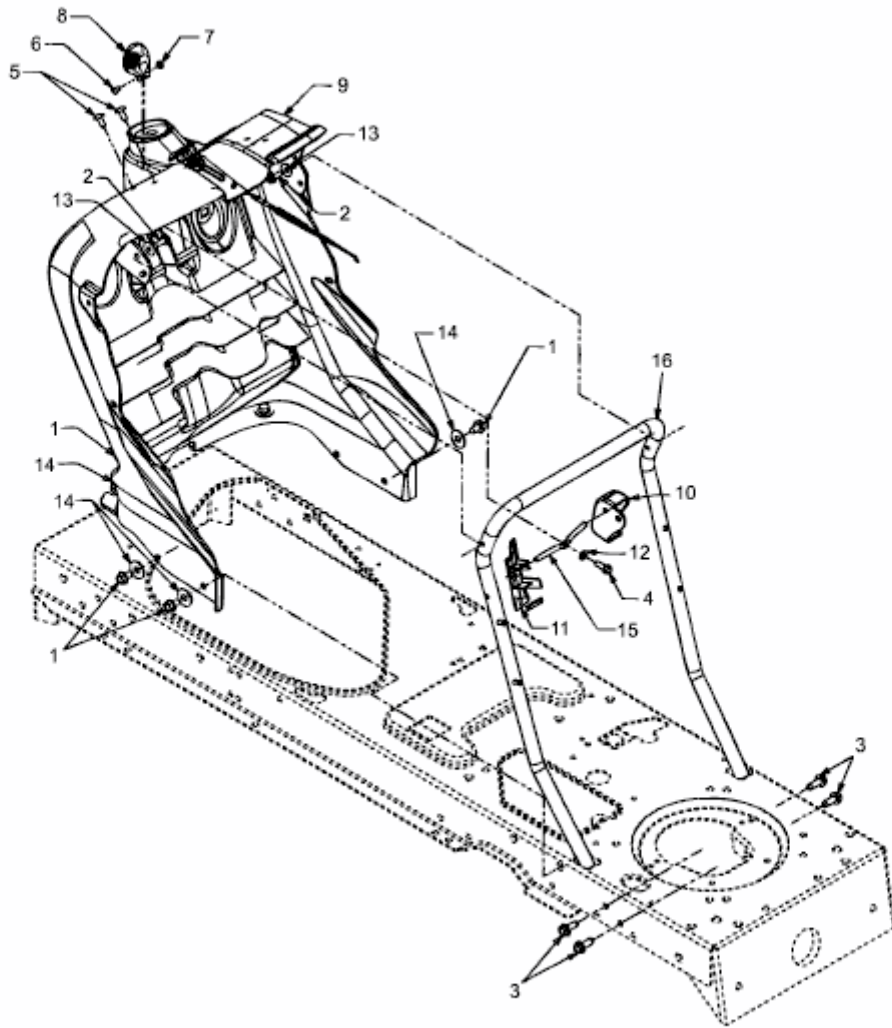

E3-01611A-02