

SN 155 H > 13AP518N678 (2002) > LENKRAD

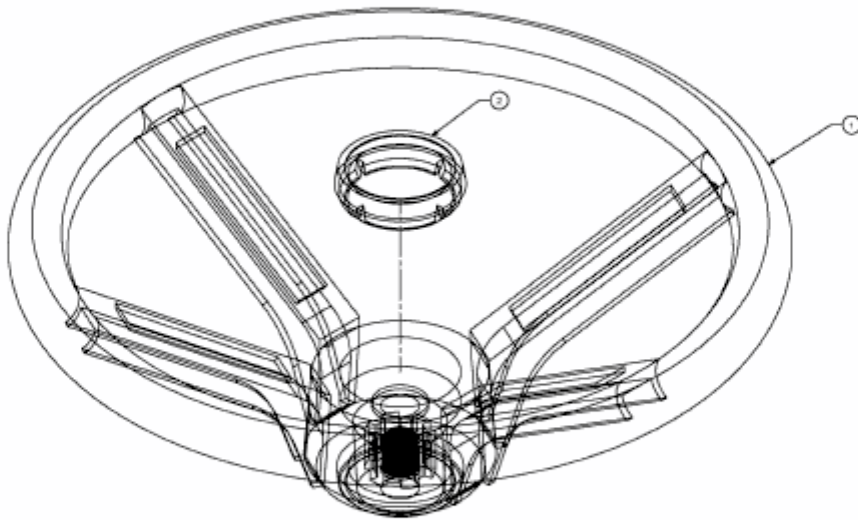

E3-07958A-01