

TA 4145 > 13AP473A643 (1999) > MESSERSPINDEL 618-0139

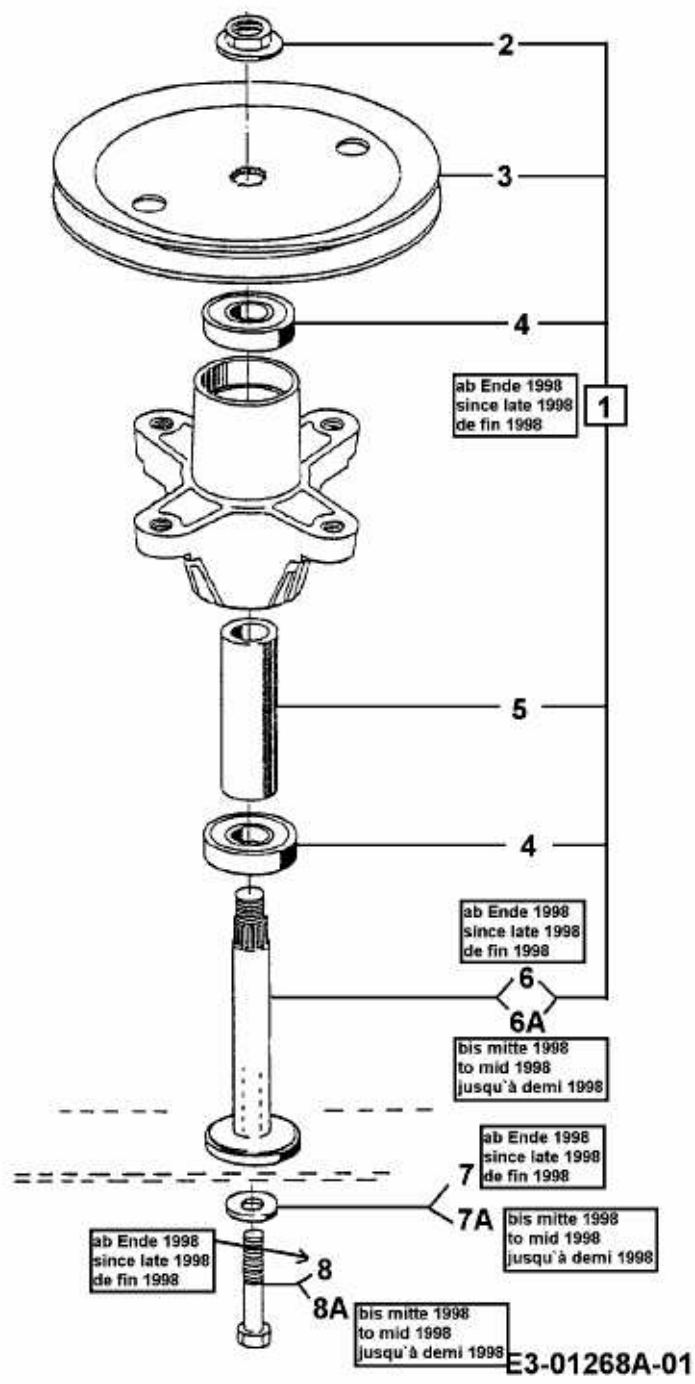

Fig