

TA 4145 > 13AP473A643 (1998) > GRASFANGKORB

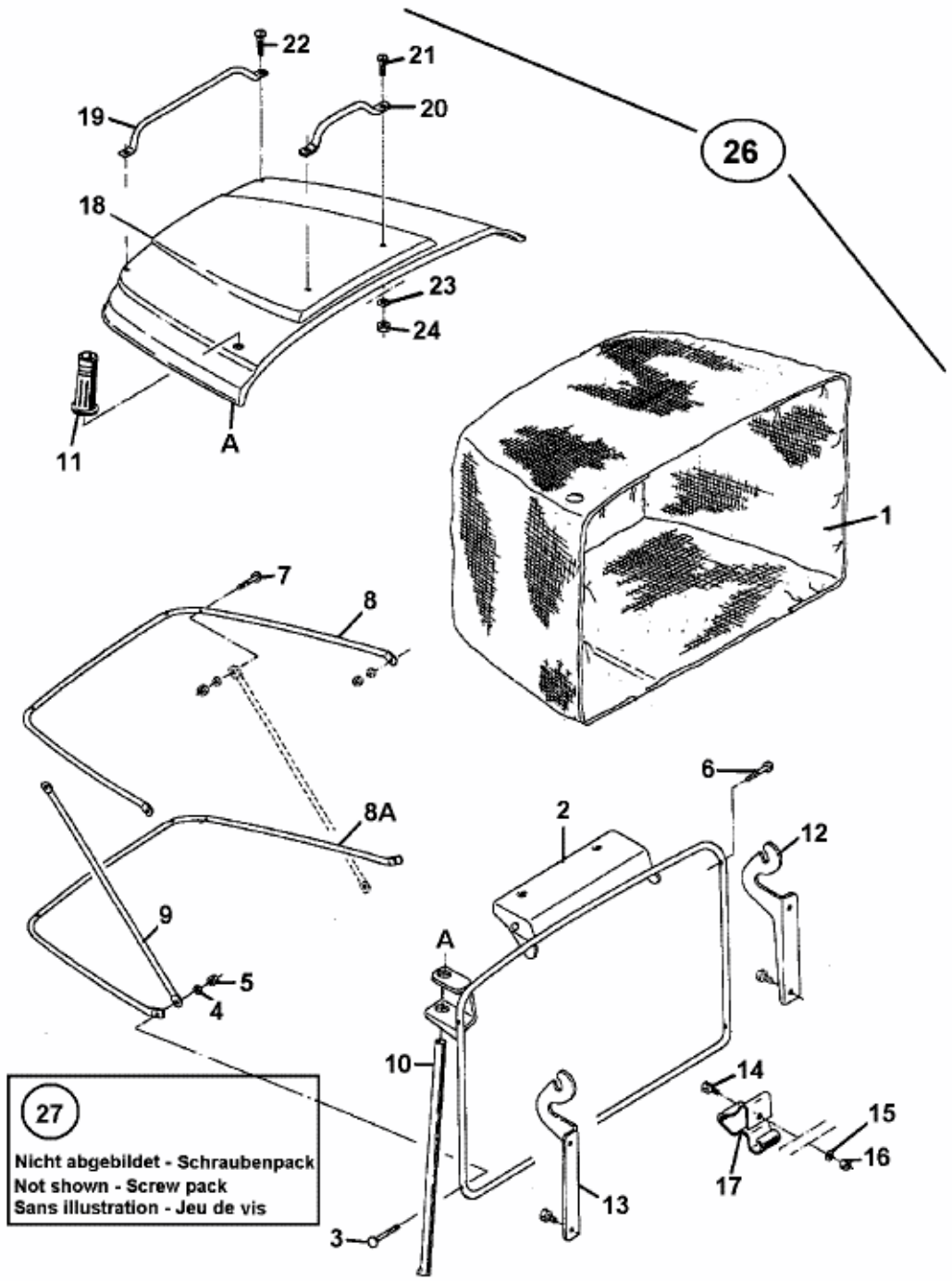

fig

E3-01389A-01