

ab 16.06.2008
from 16.06.2008
à partir du 16.06.2008

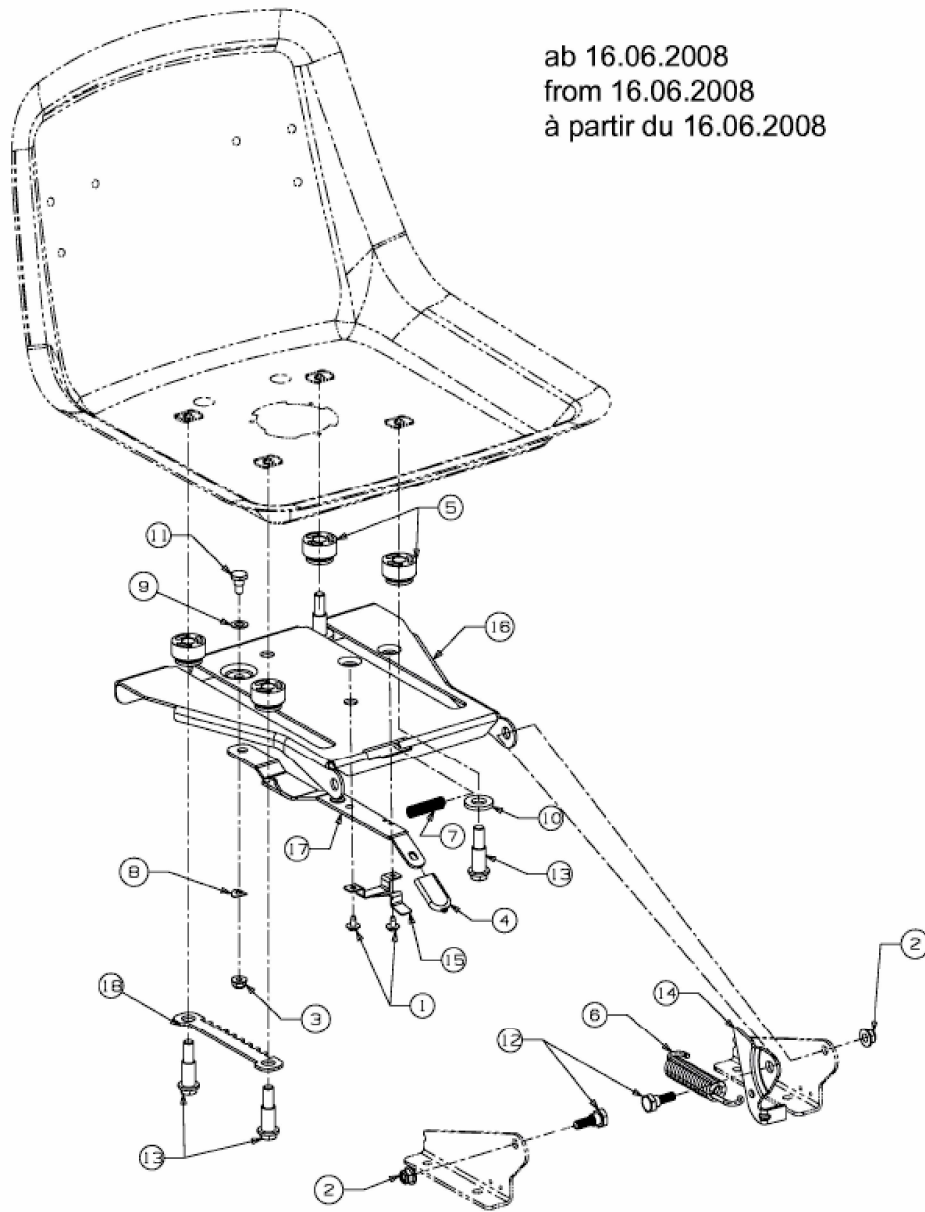

E3-04367A-01