

ab 04.11.2013
from 04.11.2013
à partir du 04.11.2013

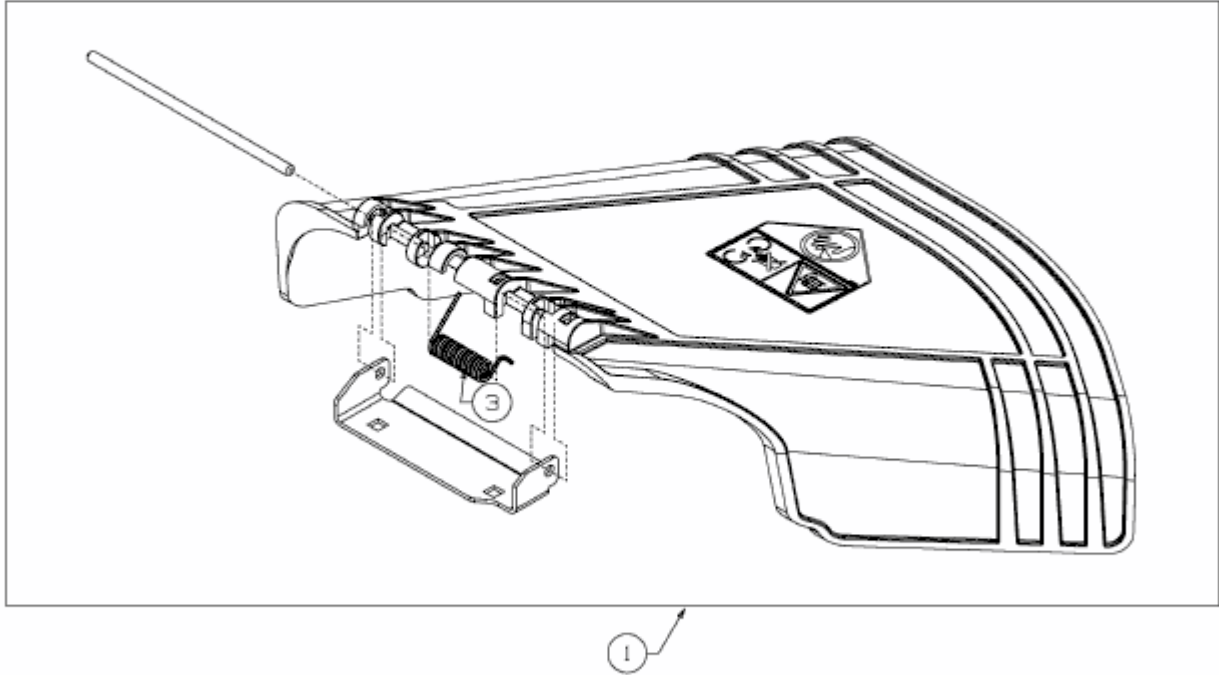

E3-02767A-01