

BL 175/107 T > 13AN775G684 (2009) > ARMATURENBRETT

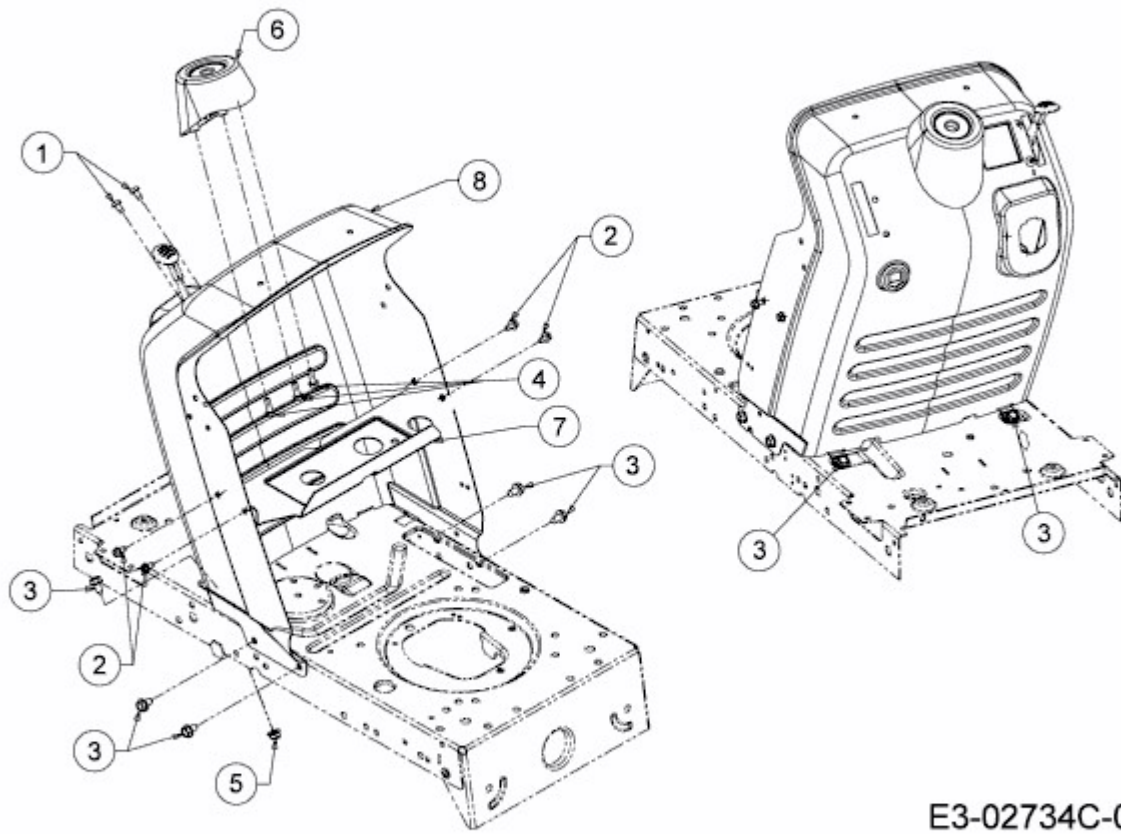

E3-02734C-01