

BL 175/107 T > 13AN775G684 (2009) > GESCHWINDIGKEITSREGELUNG, PEDALE

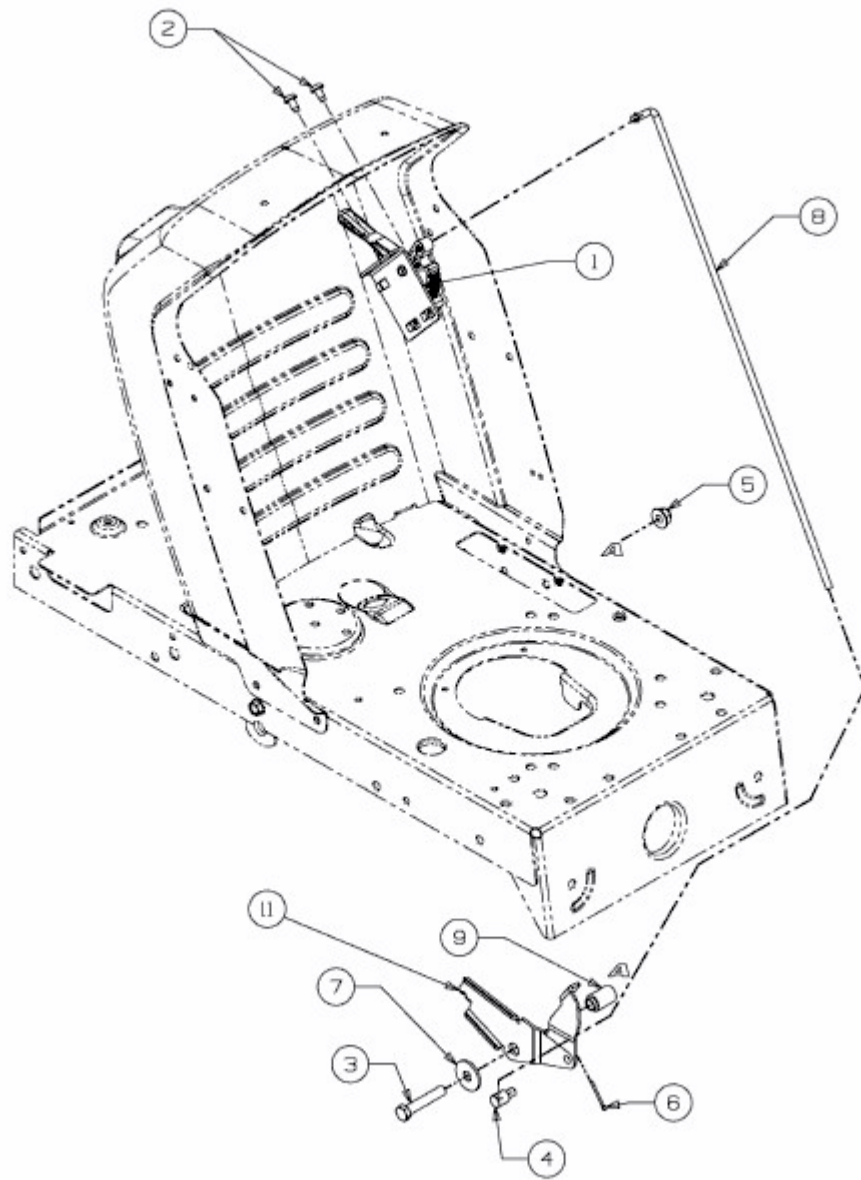

E3-02719C-01