

BL 175/107 T > 13AN775G684 (2008) > RAHMEN

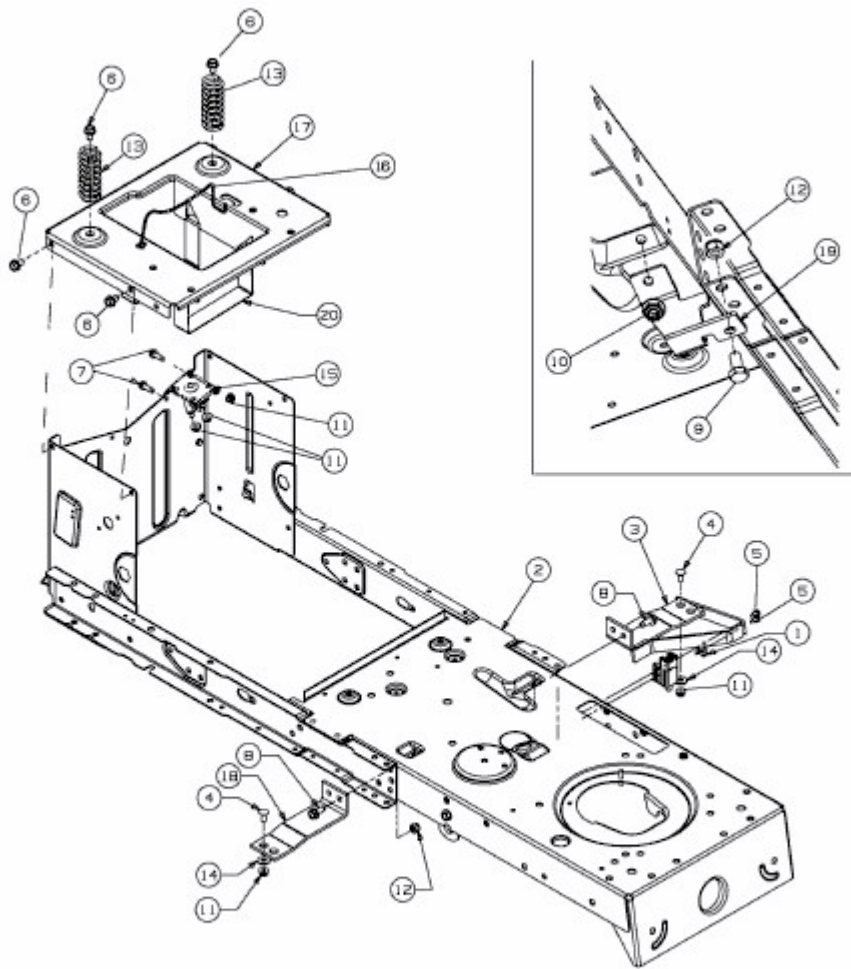

E3-02717B-01