

BL 175/107 T > 13AN775G684 (2008) > BATTERIE

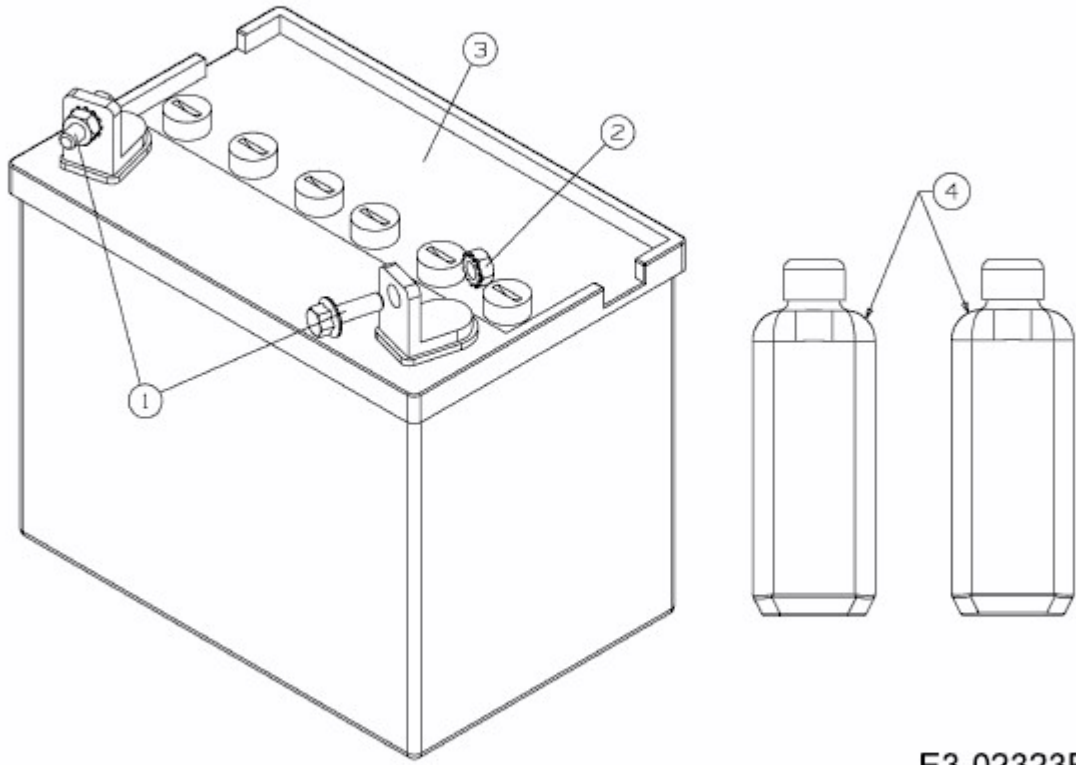

E3-02323B-01