

BL 175/107 T > 13AN775G484 (2008) > ARMATURENBRETT

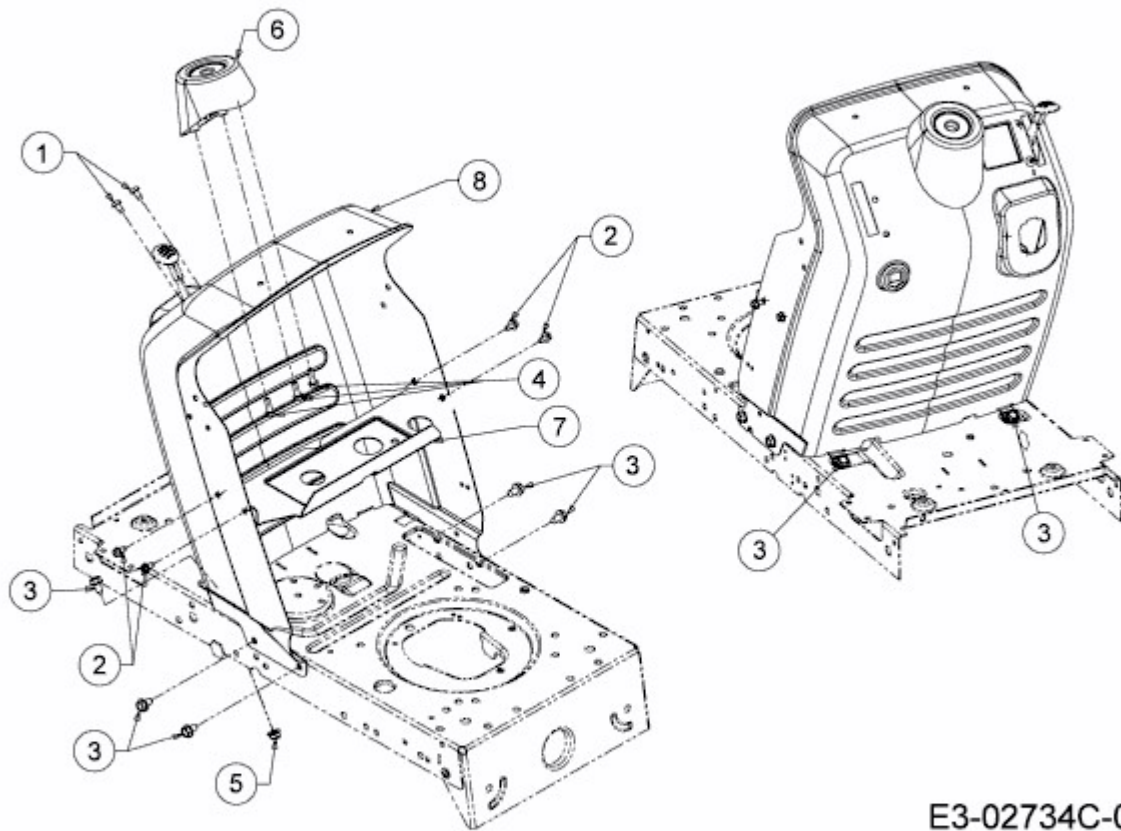

E3-02734C-01